



US007237117B2

(12) **United States Patent**  
**Weiss**

(10) **Patent No.:** **US 7,237,117 B2**  
(45) **Date of Patent:** **Jun. 26, 2007**

- (54) **UNIVERSAL SECURE REGISTRY**
- (75) Inventor: **Kenneth P. Weiss**, 59 Sargent St.,  
Newton, MA (US) 02158
- (73) Assignee: **Kenneth P. Weiss**, Newton, MA (US)
- (\* ) Notice: Subject to any disclaimer, the term of this  
patent is extended or adjusted under 35  
U.S.C. 154(b) by 814 days.
- (21) Appl. No.: **09/810,703**
- (22) Filed: **Mar. 16, 2001**

6,253,202	B1 *	6/2001	Gilmour	707/9
6,253,203	B1 *	6/2001	O'Flaherty et al.	707/9
6,260,039	B1 *	7/2001	Schneck et al.	707/10
6,308,203	B1 *	10/2001	Itabashi et al.	709/217
6,393,421	B1 *	5/2002	Paglin	707/9
6,516,315	B1 *	2/2003	Gupta	707/9
6,546,005	B1 *	4/2003	Berkley et al.	370/353
6,581,059	B1 *	6/2003	Barrett et al.	707/9
6,640,211	B1 *	10/2003	Holden	705/1
6,658,400	B2 *	12/2003	Perell et al.	707/1
6,845,448	B1 *	1/2005	Chaganti et al.	713/166
6,941,271	B1 *	9/2005	Soong	705/3
2001/0032100	A1 *	10/2001	Mahmud et al.	705/2
2002/0046061	A1 *	4/2002	Wright et al.	705/3
2004/0117215	A1 *	6/2004	Marchosky	705/3

- (65) **Prior Publication Data**  
US 2002/0178364 A1 Nov. 28, 2002
- (51) **Int. Cl.**  
**H04K 1/00** (2006.01)  
**H04L 9/00** (2006.01)
- (52) **U.S. Cl.** ..... **713/182**; 707/1; 707/3;  
707/9; 726/2; 726/4; 726/5; 726/17; 726/18;  
726/21
- (58) **Field of Classification Search** ..... 713/182,  
713/200-202; 707/1, 2, 9, 10, 3; 705/2,  
705/3, 77, 78, 79; 709/9; 726/2, 4, 5, 17,  
726/18, 21  
See application file for complete search history.

\* cited by examiner

*Primary Examiner*—Kim Vu  
*Assistant Examiner*—Beemnet W Dada  
(74) *Attorney, Agent, or Firm*—Lowrie, Lando & Anastasi, LLP.

- (56) **References Cited**  
U.S. PATENT DOCUMENTS
- |           |     |         |                 |         |
|-----------|-----|---------|-----------------|---------|
| 5,058,161 | A * | 10/1991 | Weiss           | 380/270 |
| 5,168,520 | A * | 12/1992 | Weiss           | 713/184 |
| 5,657,388 | A * | 8/1997  | Weiss           | 713/185 |
| 5,664,109 | A * | 9/1997  | Johnson et al.  | 705/2   |
| 5,813,006 | A * | 9/1998  | Polnerow et al. | 707/10  |
| 5,915,023 | A * | 6/1999  | Bernstein       | 705/75  |
| 6,073,106 | A * | 6/2000  | Rozen et al.    | 705/3   |

(57) **ABSTRACT**

A secure registry system and method for the use thereof are provided which permits secure access to a database containing selected data on a plurality of entities, at least portions of which database has restricted access. Mechanisms are provided for controlling access to restricted access portions of the database are provided, such access being determined by at least one of the identity of the requesting entity and the entity's status. A multicharacter public code may be provided which the system can map to provide permit delivery of items, complete telephone calls and perform other functions for entities. The system may also be utilized to locate an individual based on limited biological data. Organizations utilizing the system may have custom software facilitating their access and use of the system.

**12 Claims, 14 Drawing Sheets**

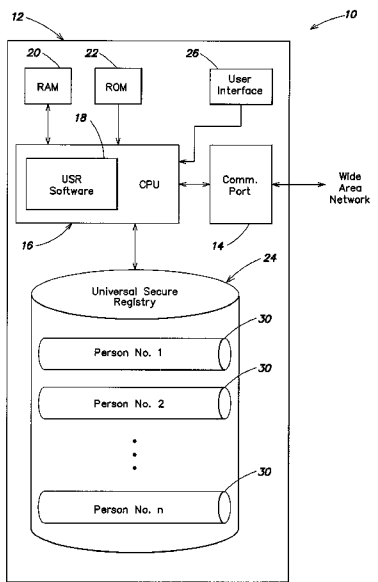

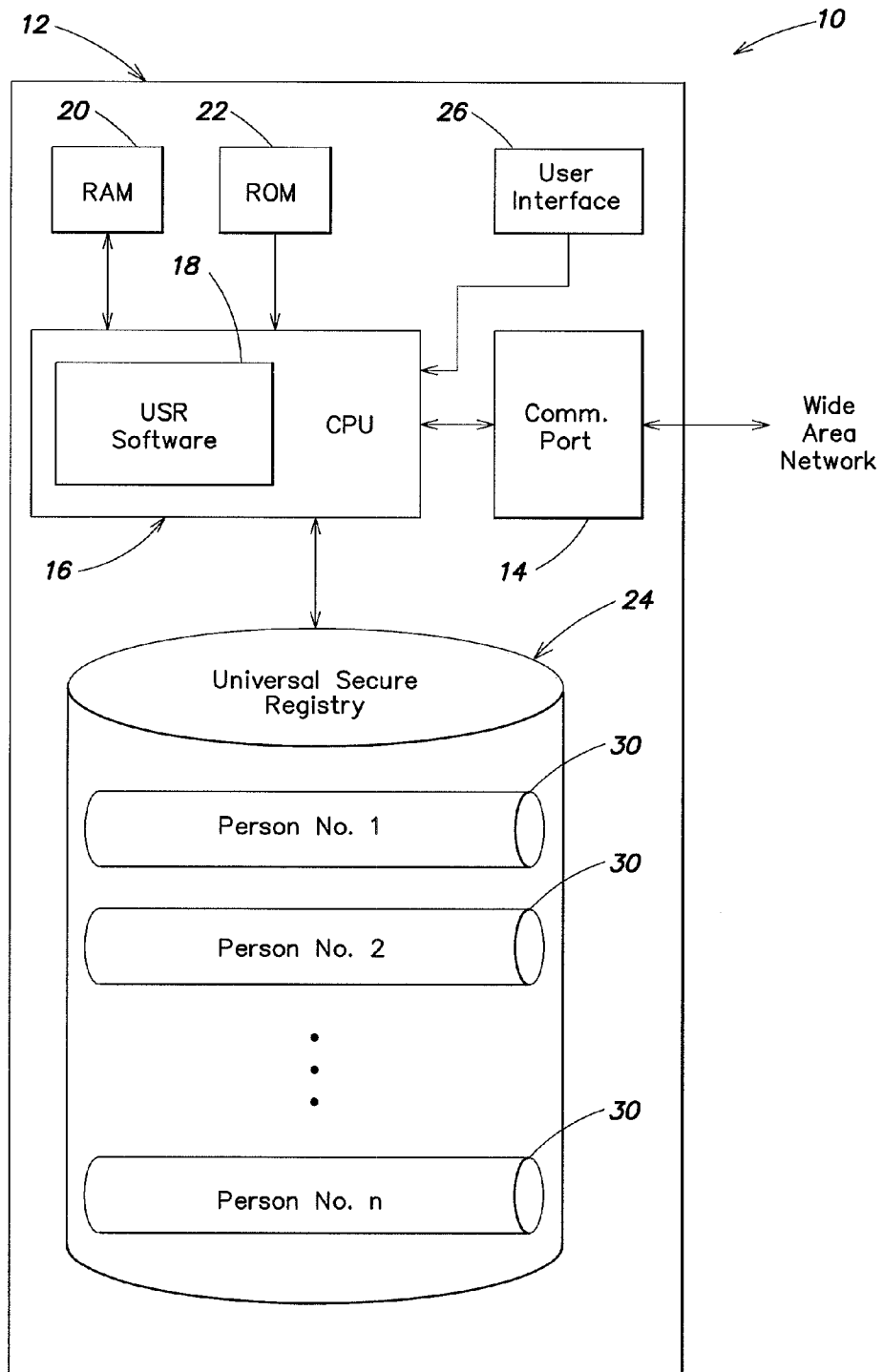

FIG. 1

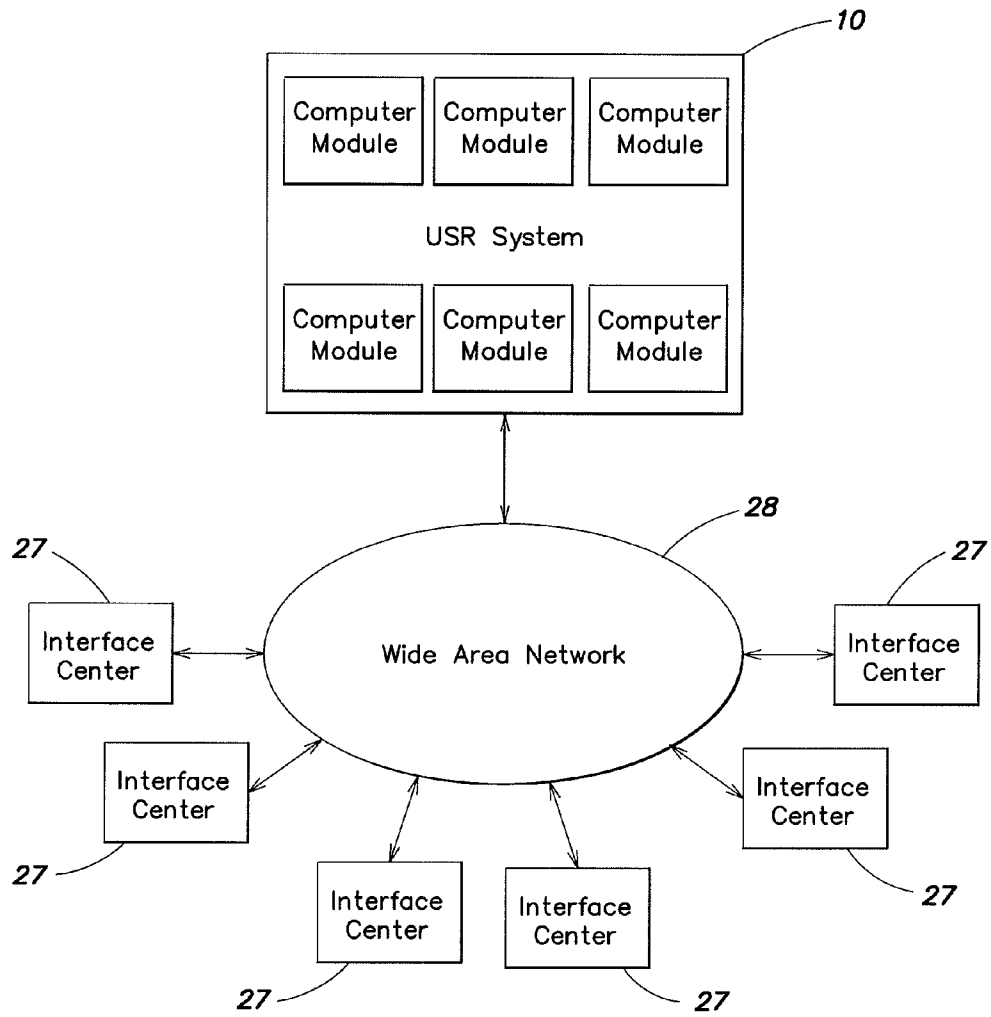

FIG. 2

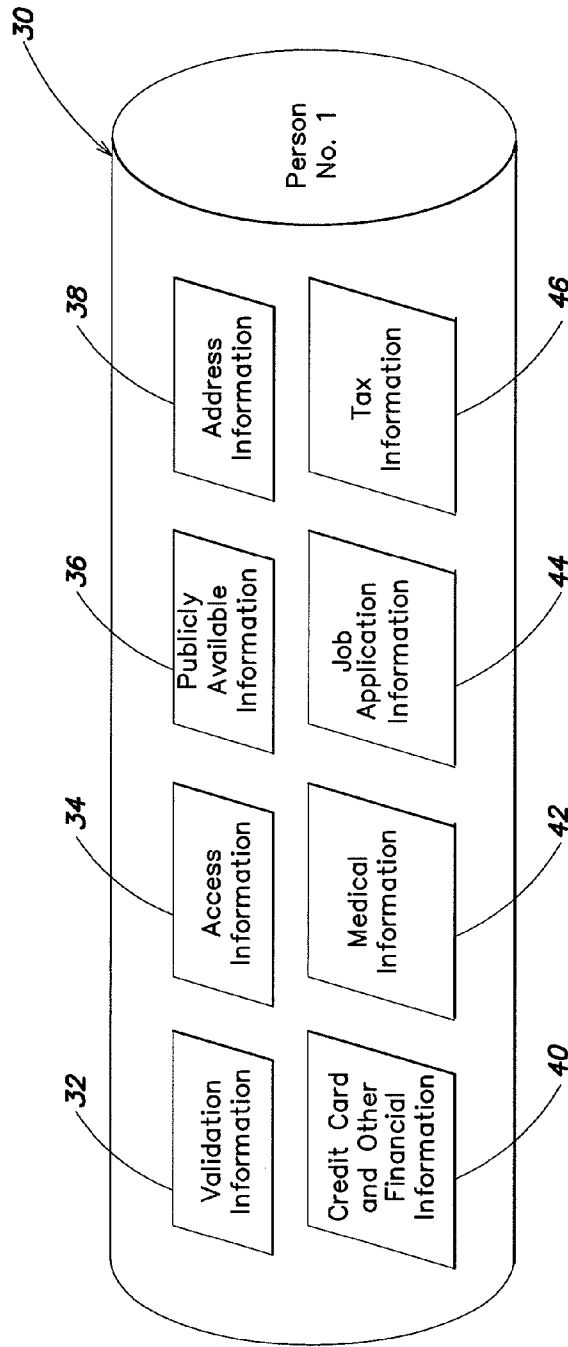

FIG. 3

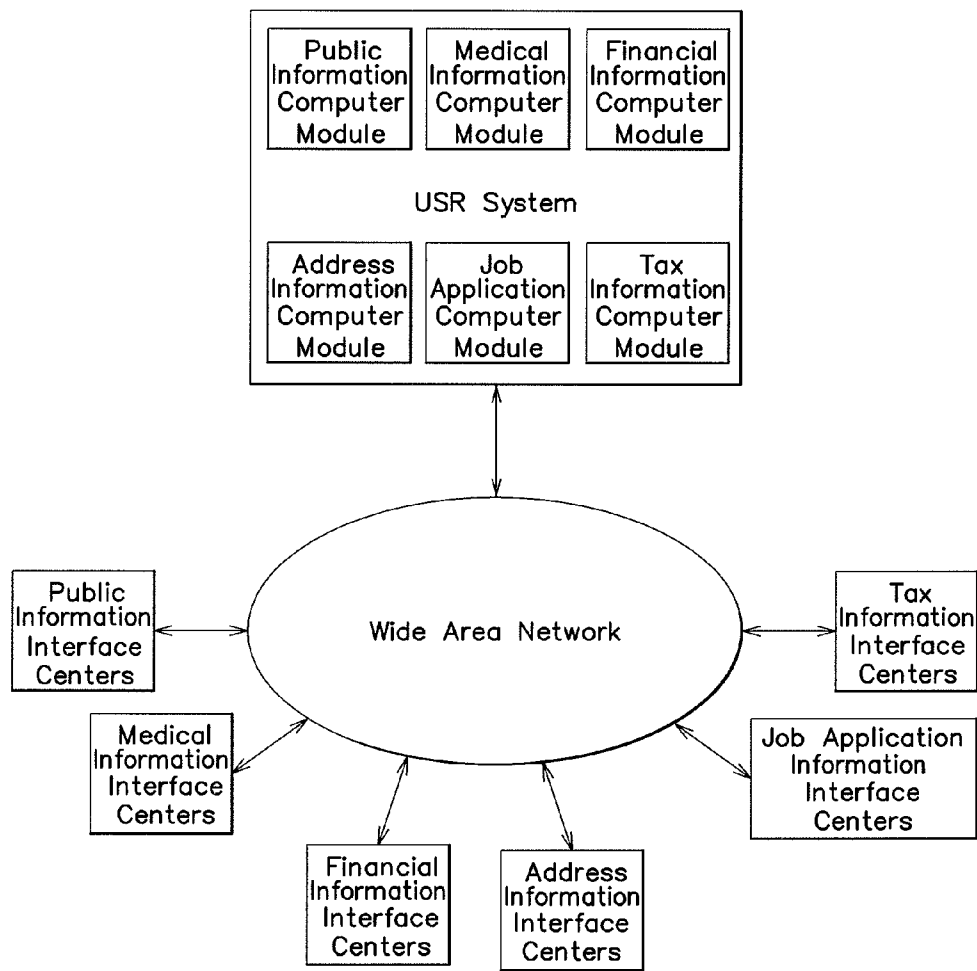

FIG. 4

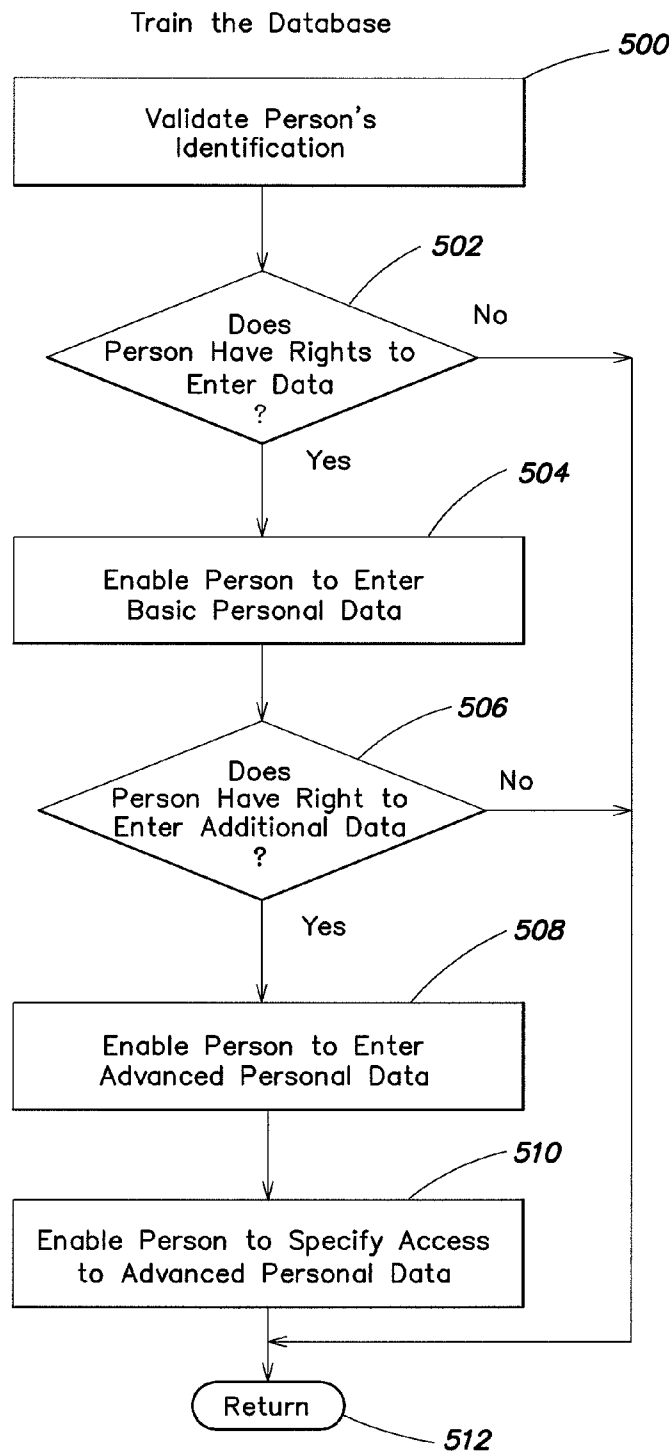

FIG. 5

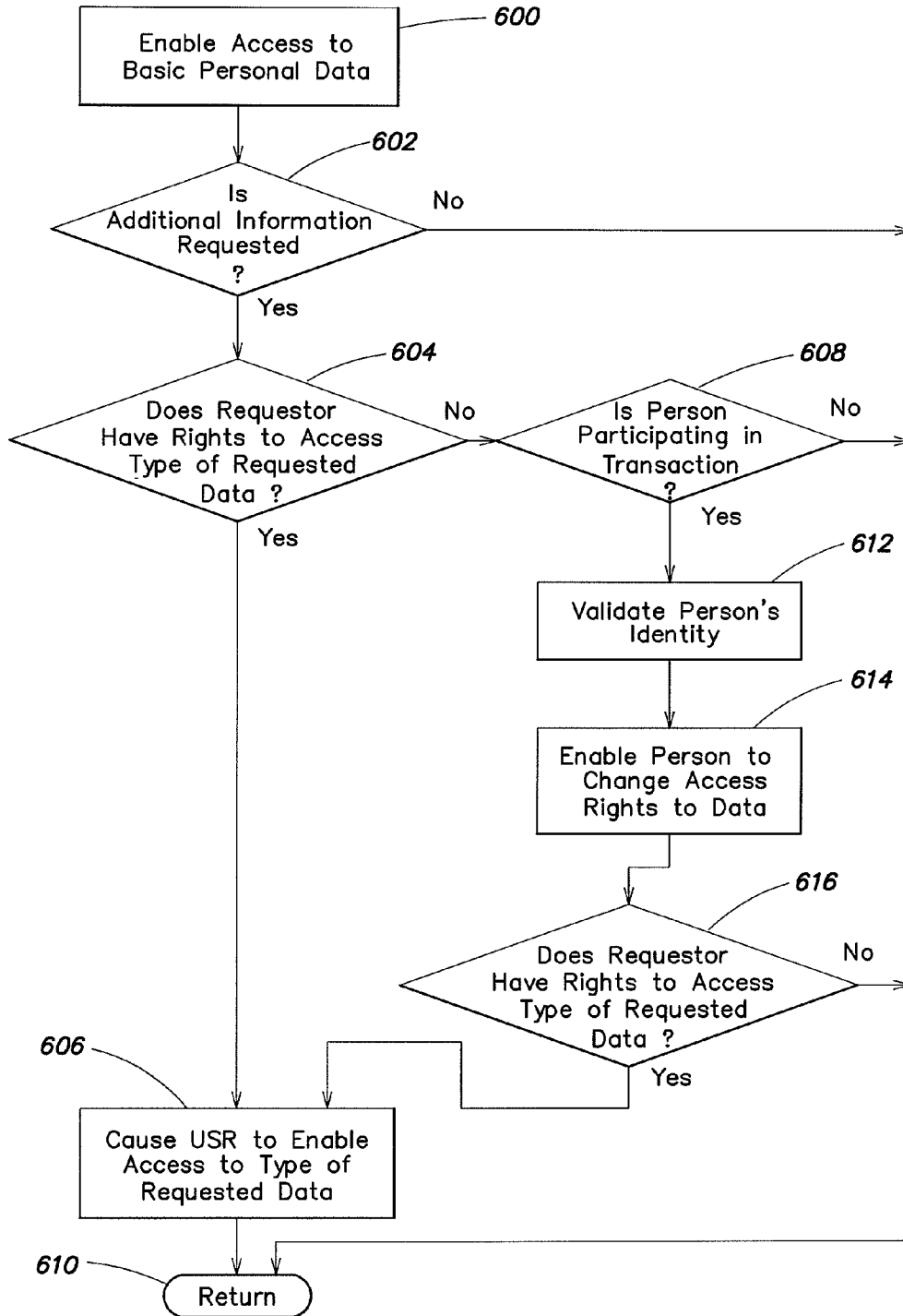
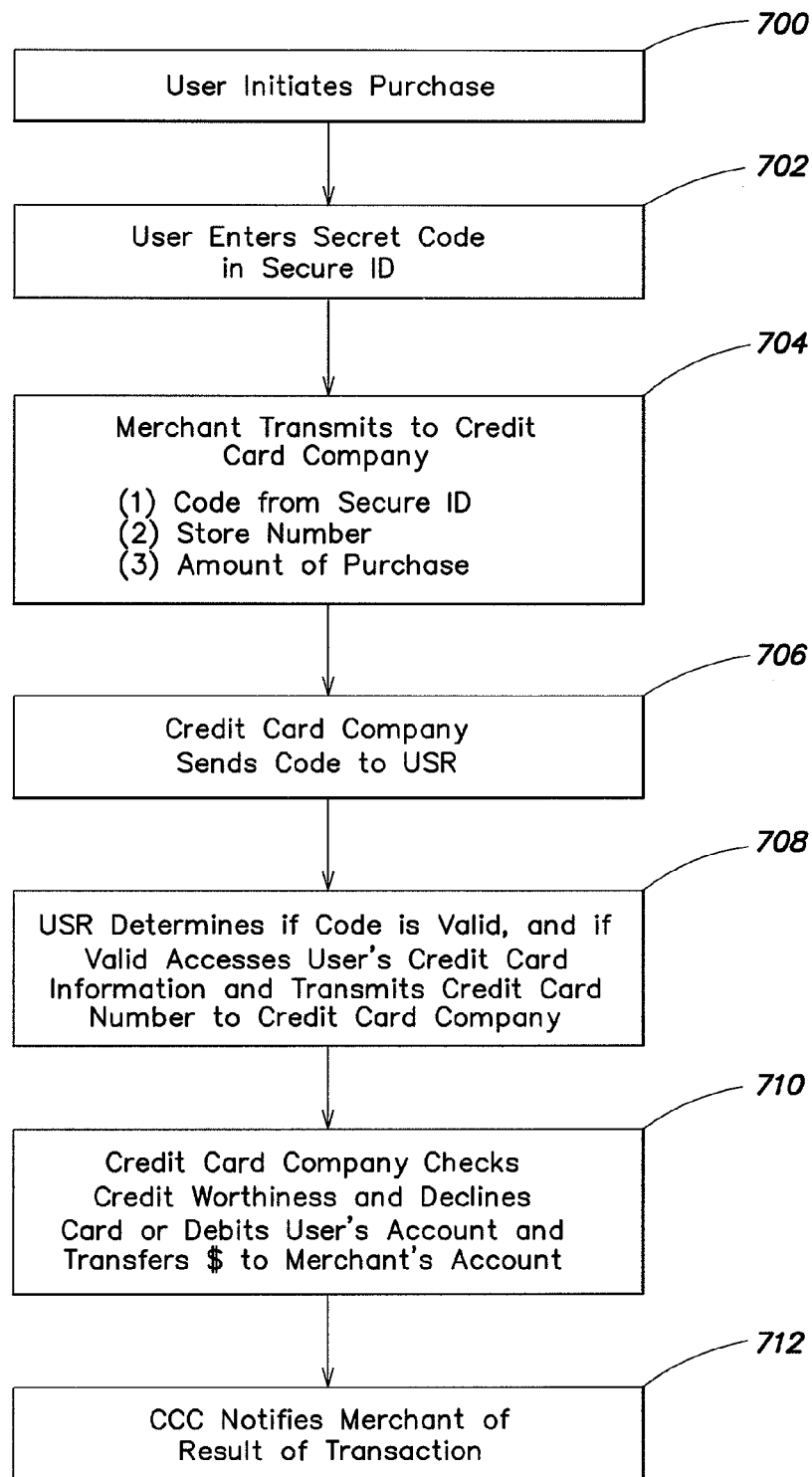
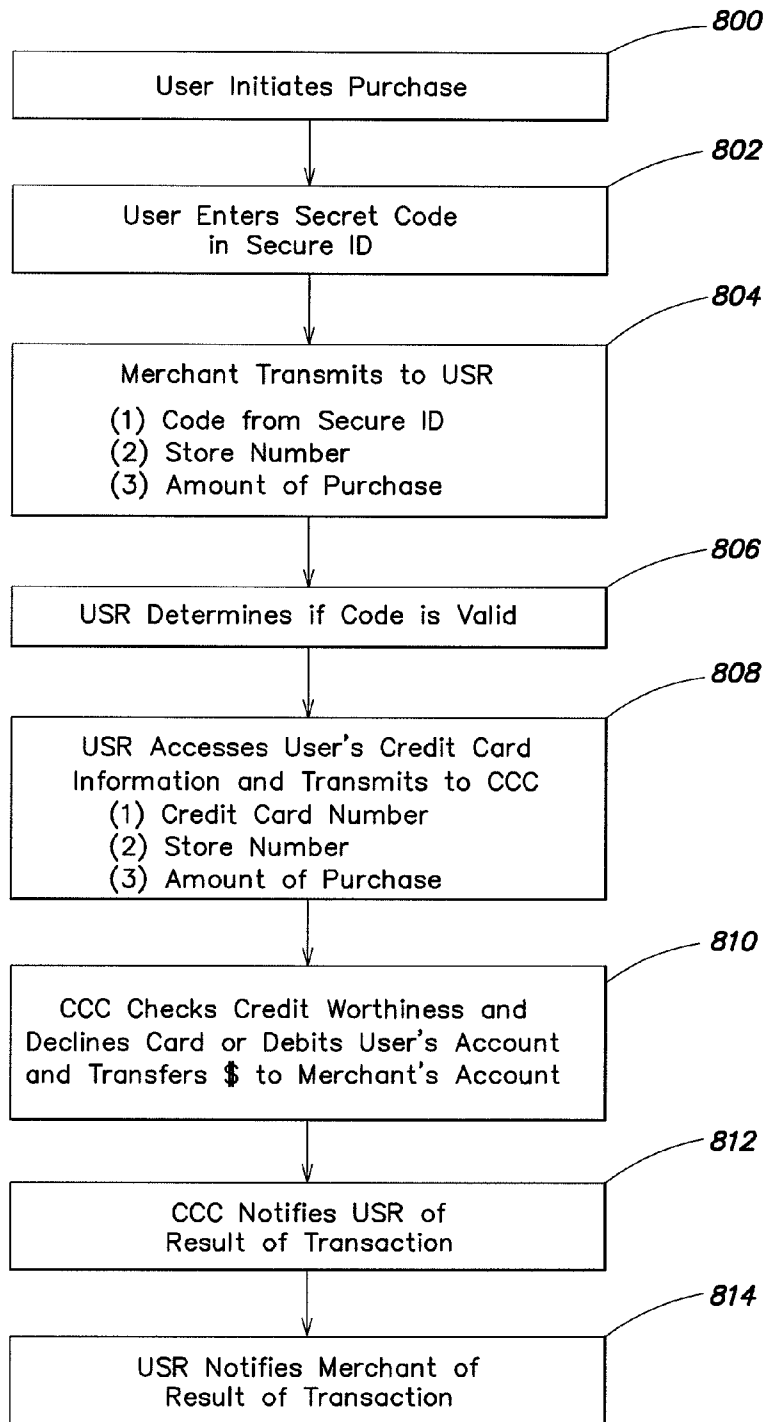

FIG. 6

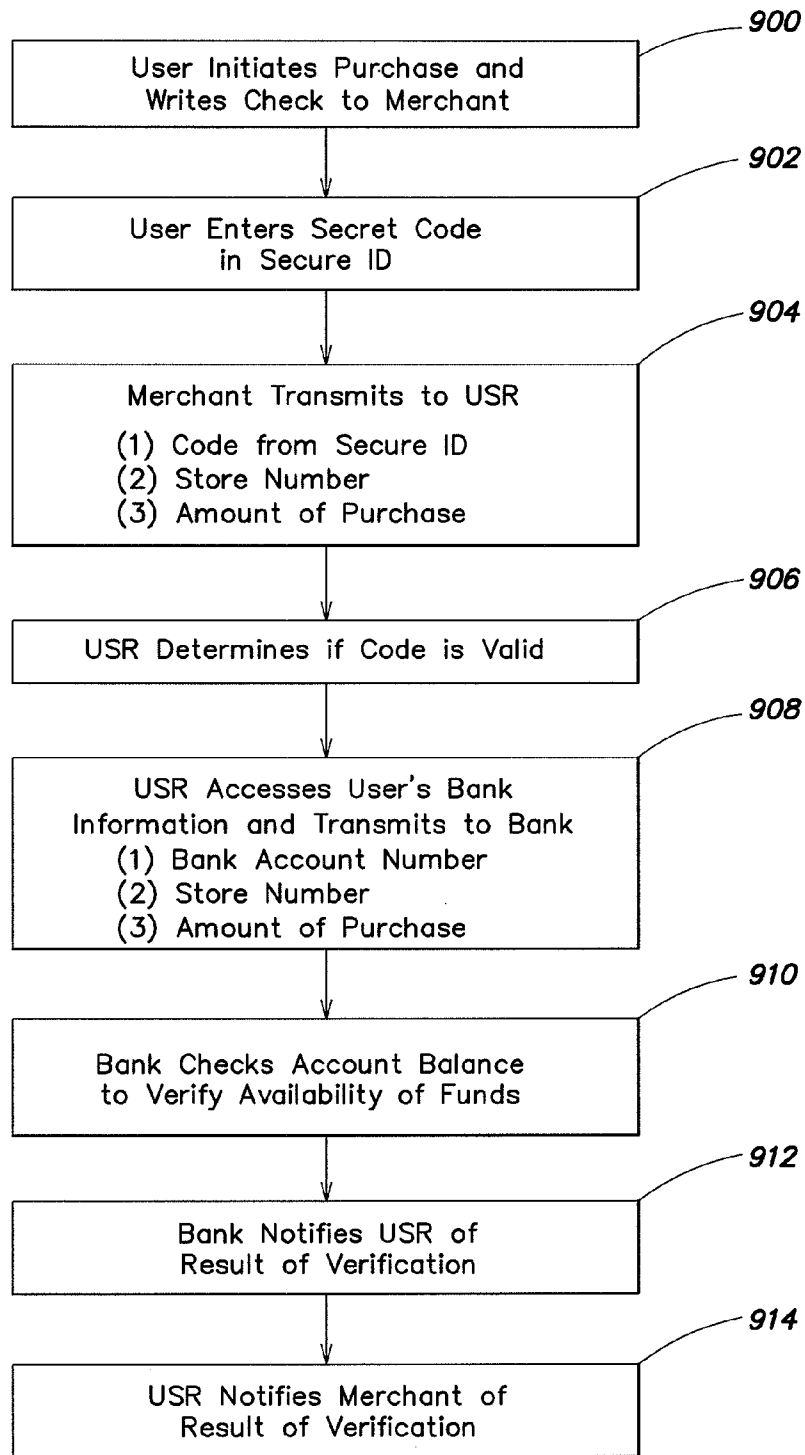

**FIG. 7**





**FIG. 8**



**FIG. 9**

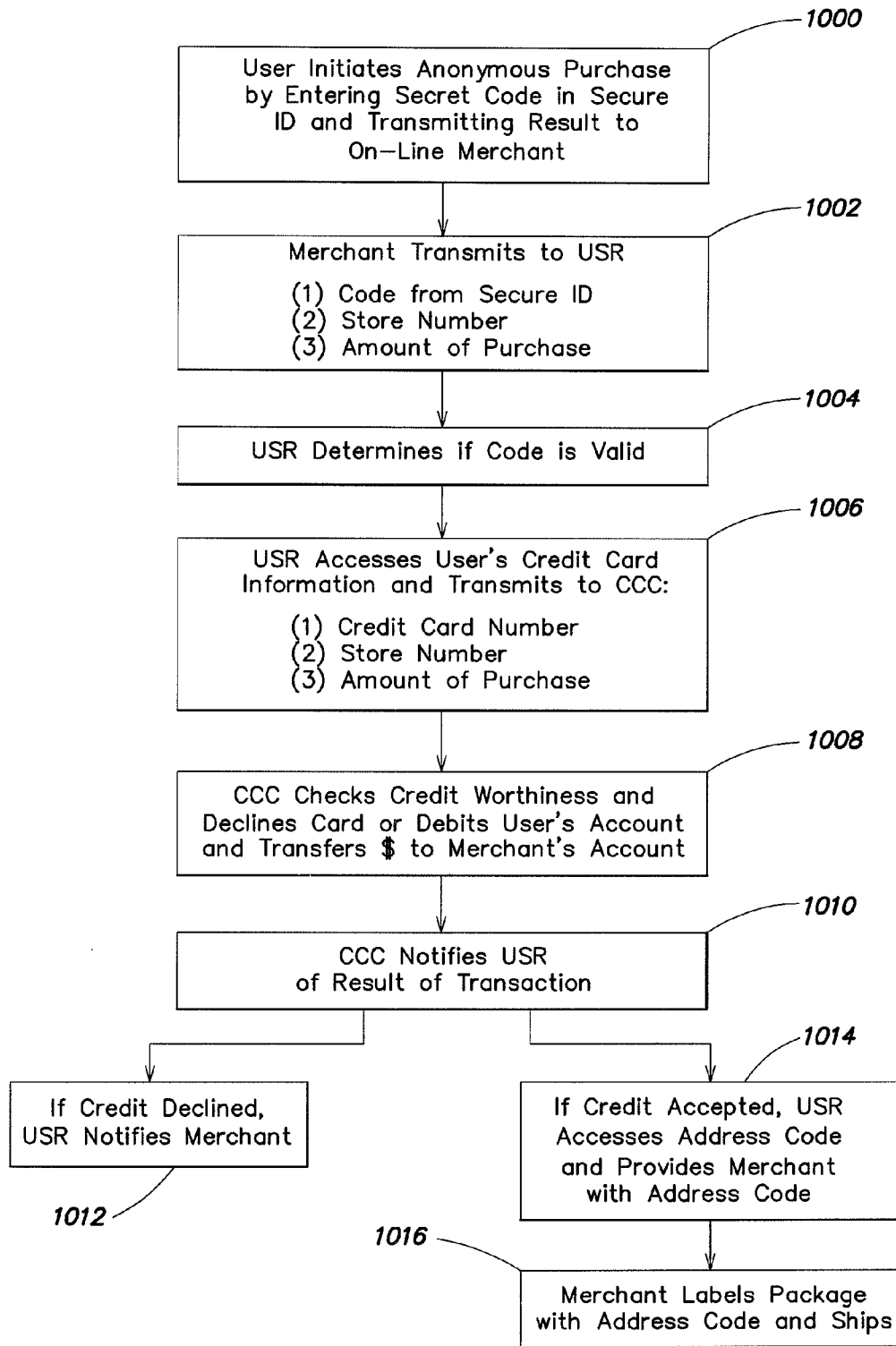

FIG. 10

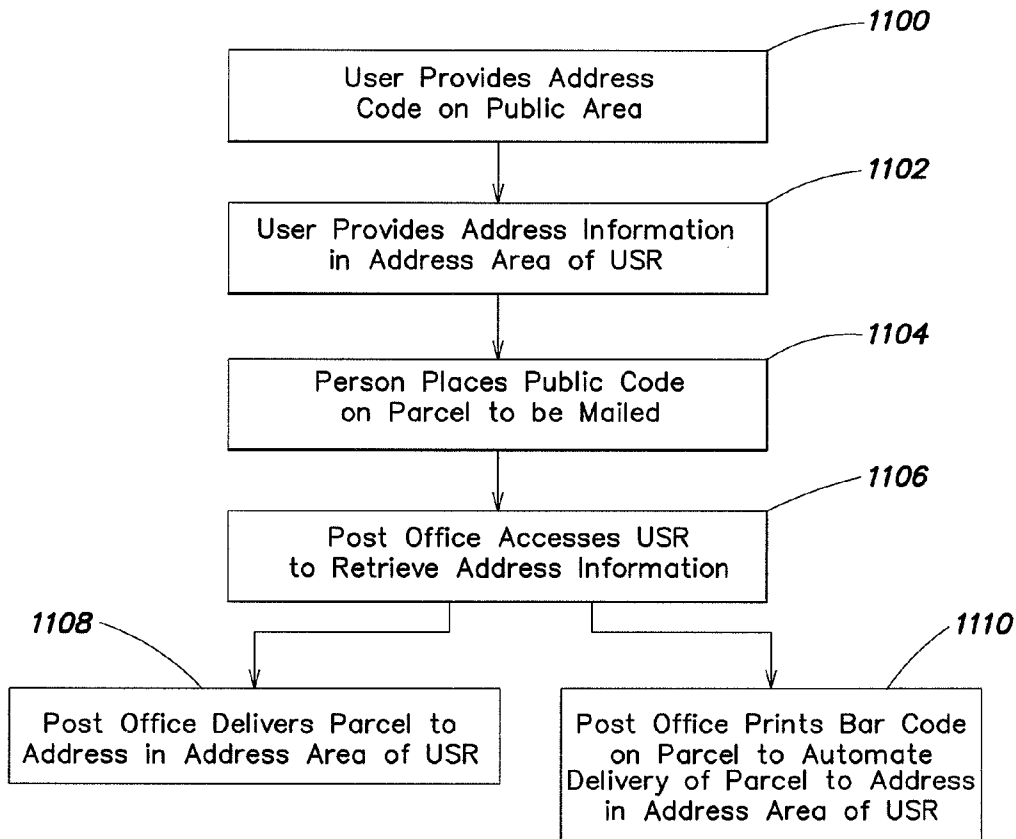

FIG. 11

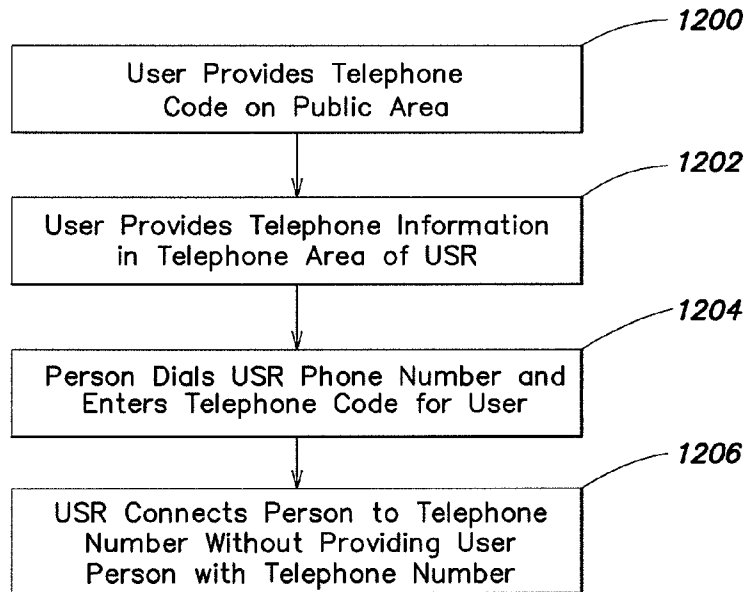

FIG. 12

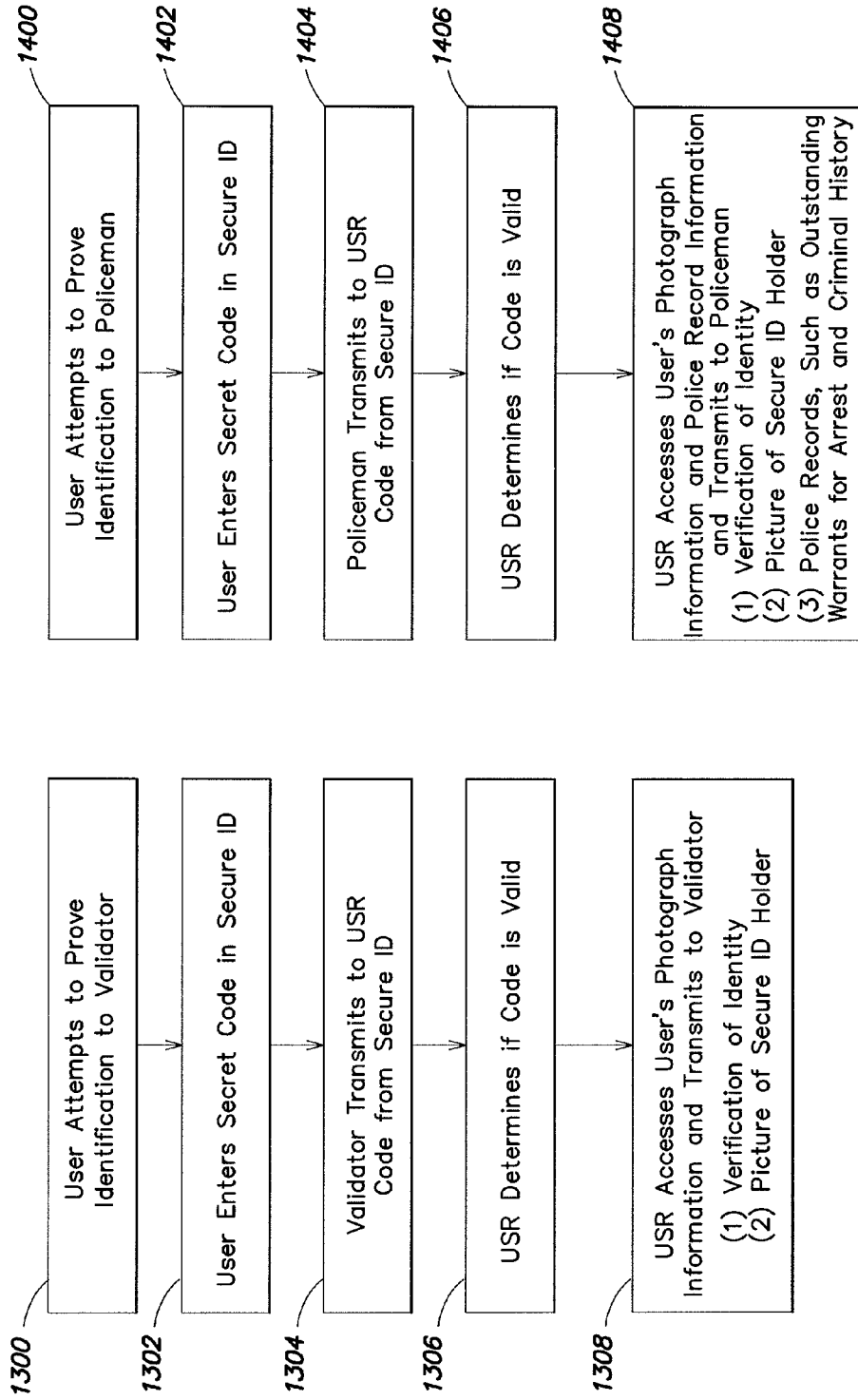

FIG. 13

FIG. 14

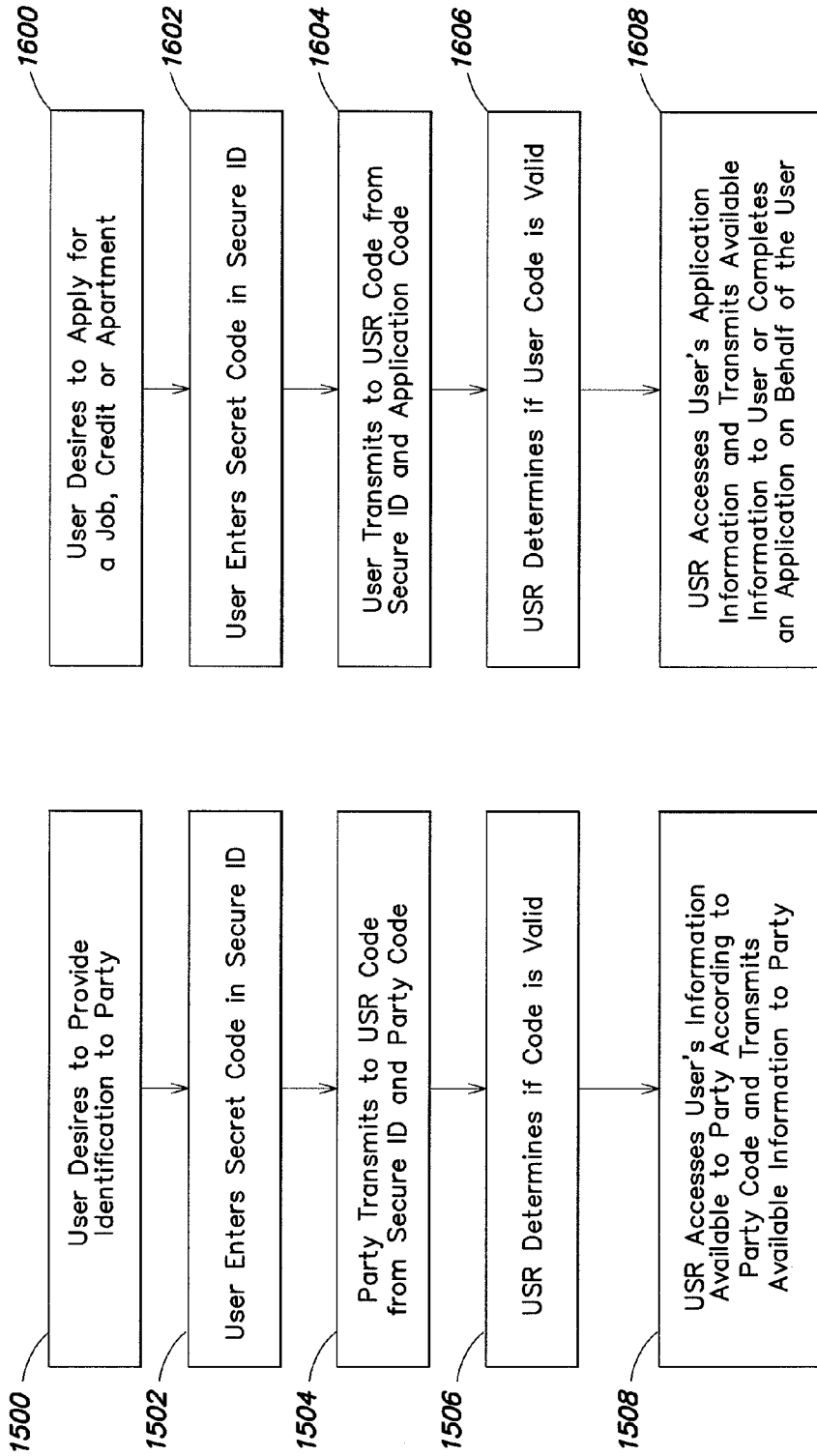
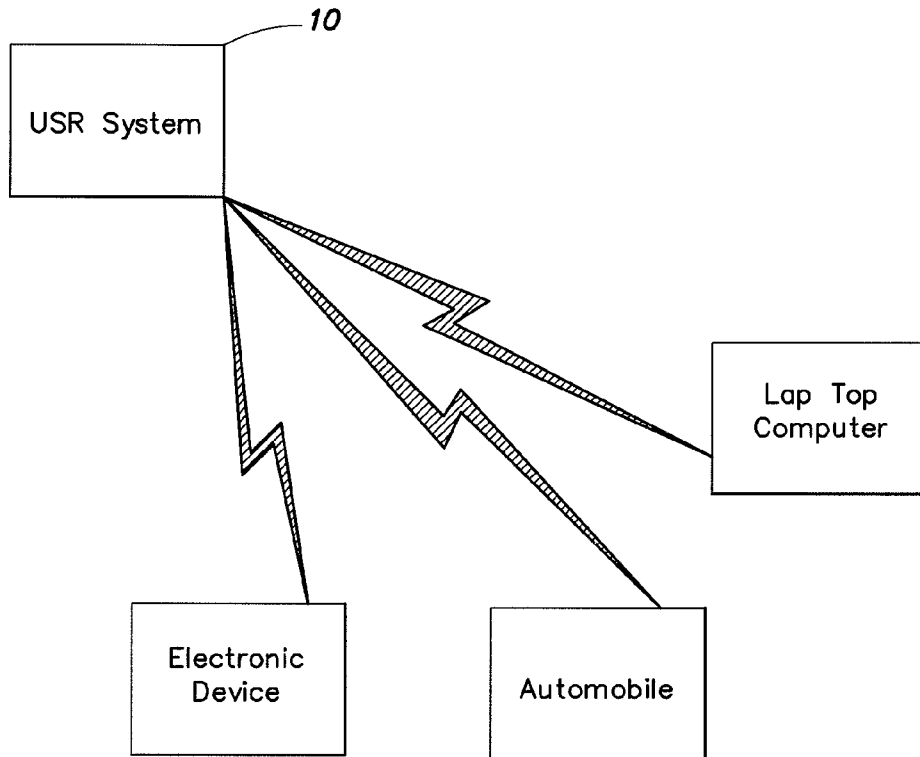

FIG. 15

FIG. 16



**FIG. 17**

**UNIVERSAL SECURE REGISTRY**

## FIELD OF THE INVENTION

This invention relates to a method and apparatus for securely storing and disseminating information regarding individuals and, more particularly, to a computer system for authenticating identity or verifying the identity of individuals and other entities seeking access to certain privileges and for selectively granting privileges and providing other services in response to such identifications/verifications.

## BACKGROUND OF THE INVENTION

Dissemination of information regarding various entities, including individuals, in society is conventionally done in a non-centralized fashion, often requiring specialized knowledge of a likely storage location to access the information. This specialized knowledge may not be available when the information is needed, thus effectively preventing distribution of the information when required. For example, a doctor in an emergency room may desire access to a patient's medical history in determining a course of treatment. If the person is not carrying a complete medical record, which is typically the situation, the medical records may not be available to the doctor. Even if these medical records are available electronically, for example via a computer accessible in the person's regular doctor's office, the records may effectively be unavailable if the person is unconscious or otherwise incapacitated or if restrictions on access to the doctor's records cannot otherwise be overcome. The retrieval of required medical records can be further complicated by the fact that such records can be located at a number of different sites/systems which are not linked. For example, the patient's primary care physician may not have records from a specialist treating the patient, and none of these physicians may have dental records. Similar problems arise in other environments where relevant data may be scattered and/or otherwise difficult to access.

Identification of a person from other persons within a society and verification of a person as being who he says he is are extremely important for many reasons. For example, determination/verification of a person's identity will typically dictate extension of credit, granting access to information, allowing entry to a restricted area, or the granting of numerous other privileges.

Most people carry multiple forms of identification. For example, a typical person may carry an identification card issued by a federal, state, or local governmental entity, an identification card issued by a university or place of employment, one or more credit cards that serve to identify the person as a holder of a credit card account, one or more bank cards that serve to identify the person as holder of a bank account, medical information cards identifying the person as a member of, for example, a health maintenance organization or as a person holding an insurance policy from a specified insurance company, keys that identify the person as owner of an automobile, house, etc., and numerous other identification cards that may be used for specialized purposes, such as identifying the person as a member of a health club, a library, or a professional organization.

To enable the person to function effectively in society, the person must typically have one or more of these identification devices with them if they wish to undertake an associated activity. For example, a person is not allowed to drive a car or purchase alcohol without a governmentally issued driver's license. Likewise, although cash may be used to

purchase goods and/or services, the person will typically not be able to purchase goods and/or services with a credit card if the person is not physically carrying the credit card. Similarly, most hospitals and other medical facilities will require proof of insurance before rendering medical attention. Carrying these multifarious identification devices can become onerous. Additionally, if one or more of the identification devices is lost, stolen or forgotten, it can be inconvenient, making it difficult to obtain goods or services requiring the missing identification.

There are also times when the individual may wish to be identified or at least verified without providing personal information. For example, a person may wish to purchase goods and/or services without publicly providing his/her credit card information for fear that the credit card information may be stolen and used fraudulently. Likewise, the person may wish to purchase goods or order goods to be delivered to an address without revealing the address to the vendor. Unfortunately, conventional identification devices require that at least some personal information be transmitted to complete a transaction.

There are other related problems. For example, when there is a need to locate a person or other entity where only limited biographical data is known, this can be difficult since relevant information is seldom available from a single database. Another potential problem is the forwarding of mail, packages, telephone calls/messages, e-mails and other items where a party is in a situation where they are changing location frequently and/or where the person does not want such information to be generally available for security or other reasons. A simple, yet secure, way of dealing with such issues does not currently exist.

Another potential problem is filling in forms, particularly for an individual who frequently has to complete the same or similar form. Such forms can for example be medical forms when visiting a doctor or entering a hospital, immigration forms on entering the country, employment forms, college entry forms, etc. It would be desirable if such forms could be completed once and be available for future use, and it would be even better if the information for each such form could be automatically drawn from an existing database to complete the form. There is also a frequent requirement to periodically update information in a form, for example financial information for a line of credit. It would be desirable if such updates could be automatically performed from data in a general database.

Still another potential problem is that a person may be forced to make requests on a database, for example financial requests, under duress. It would be desirable if the person could easily and undetectably signal such duress when making the request and the receiving system be able to act appropriately to assist and protect the individual.

Systems capable of effectively performing all of these functions do not currently exist.

## SUMMARY OF THE INVENTION

There is thus a need for an identification system that will enable a person to be identified or verified ("identification" sometimes being used hereinafter to mean either identified or verified) and/or authenticated without necessitating the provision of any personal information. Likewise, there is a need for an identification system that will enable a person to be identified universally without requiring the person to carry multiple forms of identification.

Accordingly, this invention relates, in one embodiment, to an information system that may be used as a universal



identification system and/or used to selectively provide personal, financial or other information about a person to authorized users. Transactions to and from the database may take place using a public key/private key security system to enable users of the system and the system itself to encrypt transaction information during the transactions. Additionally, the private key/public key security system may be used to allow users to validate their identity and/or sign instructions being sent to a universal secure registry (USR) system of the type to which this invention relates. For example, in one embodiment, a smart card such as the Secure ID™ card from RSI Security, Inc. may be provided with the user's private key and the USR system's public key to enable the card to encrypt messages being sent to the USR system and to decrypt messages from the USR system 10.

This USR system or database may be used to identify the person in many situations, and thus may take the place of multiple conventional forms of identification. Additionally, the USR system may enable the user's identity to be confirmed or verified without providing any identifying information about the person to the entity requiring identification. This can be advantageous where the person suspects that providing identifying information may subject the identifying information to usurpation.

Enabling anonymous identification facilitates multiple new forms of transactions. For example, enabling anonymous identification enables the identified person to be telephoned by or receive e-mails from other persons without providing the other person with a telephone number or e-mail address, and will permit this to be accomplished even where there are frequent changes in the persons location. Similarly, enabling anonymous identification will enable the person to receive mail, other delivered parcels and other items without providing the recipient's address information to the sender. By restricting access to particular classes of persons/entities, the person can effectively prevent receipt of junk mail, other unsolicited mail, telemarketing calls and the like.

In a financial context, providing anonymous identification of a person enables the person to purchase goods and/or services from a merchant without ever transmitting to the merchant information, such as the person's credit card number, or even the persons name, that could be intercepted and/or usurped and used in subsequent or additional unauthorized transactions or for other undesired purposes. Enabling anonymous identification may be particularly advantageous in an unsecured environment, such as the Internet, where it has been found to be relatively trivial to intercept such credit card information.

In a medical context, the USR system, in addition to enabling a person seeking medical treatment to identify themselves, may be configured to provide insurance data, medical history data, and other appropriate medical information to a medical provider, once that medical provider has been established as an authorized recipient. The USR system may also contain links to other databases containing portions of the patients medical records, for example x-rays, MRI pictures, dental records, glasses, prescriptions, etc.

Access to the USR system may be by smart card, such as a Secure ID™ card, or any other secure access device. The technology enabling the USR system may be physically embodied as a separate identification device such as a smart ID card, or may be incorporated into another electronic device, such as a cell phone, pager, wrist watch, computer, personal digital assistant such as a Palm Pilot™, key fob, or other commonly available electronic device. The identity of the user possessing the identifying device may be verified at

the point of use via any combination of a memorized PIN number or code, biometric identification such as a fingerprint, voice print, signature, iris or facial scan, or DNA analysis, or any other method of identifying the person possessing the device. If desired, the identifying device may also be provided with a picture of the person authorized to use the device to enhance security.

The USR system may be useful for numerous other identification purposes. For example, the USR anonymous identification may serve as a library card, a phone card, a health club card, a professional association membership card, a parking access card, a key for access to ones home, office, car, etc. or any one of a host of similar identification/verification and/or access functions. Additionally, equipment code information may be stored in the USR system and distributed under the user's control and at the user's discretion, to maintain personal property or public property in an operative state.

#### BRIEF DESCRIPTION OF THE FIGURES

This invention is pointed out with particularity in the appended claims. The above and further advantages of this invention may be better understood by referring to the following description when taken in conjunction with the accompanying drawings. The accompanying drawings are not intended to be drawn to scale. In the drawings, each identical or nearly identical component that is illustrated in various figures is represented by a like numeral. For purposes of clarity, not every component may be labeled in every drawing. In the drawings:

FIG. 1 is a functional block diagram of a computer system configured to implement the universal secure registry ("USR"), including a USR database, according to one embodiment of the invention;

FIG. 2 is a functional block diagram of a first embodiment of a networked environment including the computer system of FIG. 1;

FIG. 3 is a functional block diagram of an entry of a database forming the USR database of FIG. 1

FIG. 4 is a functional block diagram of a second embodiment of a networked environment including the computer system of FIG. 1;

FIG. 5 is a flow chart illustrating steps in a process of inputting data into the USR database;

FIG. 6 is a flow chart illustrating steps in a process of retrieving data from the USR database;

FIG. 7 is a flow chart illustrating a first protocol for purchasing goods from a merchant via the USR database without transmitting credit card information to the merchant;

FIG. 8 is a flow chart illustrating a second protocol for purchasing goods from a merchant via the USR database without transmitting credit card information to the merchant;

FIG. 9 is a flow chart illustrating a protocol for purchasing goods from a merchant via the USR database by validating the user's check;

FIG. 10 is a flow chart illustrating a protocol for purchasing goods from an on-line merchant via the USR database without transmitting credit card information to the on-line merchant, and enabling the on-line merchant to ship the goods to a virtual address;

FIG. 11 is a flow chart illustrating a protocol for shipping goods to a virtual address via the USR database;

FIG. 12 is a flow chart illustrating a protocol for telephoning a virtual phone number via the USR database;

FIG. 13 is a flow chart illustrating a protocol for identifying a person via the USR database;

FIG. 14 is a flow chart illustrating a protocol for identifying a person to a policeman via the USR database;

FIG. 15 is a flow chart illustrating a protocol for providing information to an authorized recipient of the information via the USR database;

FIG. 16 is a flow chart illustrating a protocol for providing application information to an authorized recipient of the information via the USR database; and

FIG. 17 is a functional block diagram of an embodiment configured to use information in the USR system to activate or keep active property secured through the USR system.

#### DETAILED DESCRIPTION OF THE INVENTION

In one embodiment, an information system is formed as a computer program running on a computer or group of computers configured to provide a universal secure registry (USR) system. The computer, in this instance, may be configured to run autonomously (without the intervention of a human operator), or may require intervention or approval for all, a selected subset, or particular classes of transactions. The invention is not limited to the disclosed embodiments, and may take on many different forms depending on the particular requirements of the information system, the type of information being exchanged, and the type of computer equipment employed. An information system according to this invention, may optionally, but need not necessarily, perform functions additional to those described herein, and the invention is not limited to a computer system performing solely the described functions.

In the embodiment shown in FIG. 1, a computer system 10 for implementing a USR system according to the invention includes at least one main unit 12 connected to a wide area network, such as the Internet, via a communications port 14. The main unit 12 may include one or more processors (CPU 16) running USR software 18 configured to implement the USR system functionality discussed in greater detail below. The CPU 16 may be connected to a memory system including one or more memory devices, such as a random access memory system RAM 20, a read only memory system ROM 22, and one or more databases 24. In the illustrated embodiment, the database 24 contains a universal secure registry database. The invention is not limited to this particular manner of storing the USR database. Rather, the USR database may be included in any aspect of the memory system, such as in RAM 20, ROM 22 or disc and may also be separately stored on one or more dedicated data servers.

The computer system may be a general purpose computer system which is programmable using a computer programming language, such as C, C++, Java, or other language, such as a scripting language or even assembly language. The computer system may also be specially programmed, special purpose hardware, an application specific integrated circuit (ASIC) or a hybrid system including both special purpose components and programmed general purpose components.

In a general purpose computer system, the processor is typically a commercially available microprocessor, such as Pentium series processor available from Intel, or other similar commercially available device. Such a microprocessor executes a program called an operating system, such as UNIX, Linux, Windows NT, Windows 95, 98, or 2000, or any other commercially available operating system, which controls the execution of other computer programs and provides scheduling, debugging, input/output control, accounting, compilation, storage assignment, data manage-

ment, memory management, communication control and related services, and many other functions. The processor and operating system defines a computer platform for which application programs in high-level programming languages are written.

The database 24 may be any kind of database, including a relational database, object-oriented database, unstructured database, or other database. Example relational databases include Oracle 8i from Oracle Corporation of Redwood City, Calif.; Informix Dynamic Server from Informix Software, Inc. of Menlo Park, Calif.; DB2 from International Business Machines of Armonk, N.Y.; and Access from Microsoft Corporation of Redmond, Wash. An example object-oriented database is ObjectStore from Object Design of Burlington, Mass. An example of an unstructured database is Notes from the Lotus Corporation, of Cambridge, Mass. A database also may be constructed using a flat file system, for example by using files with character-delimited fields, such as in early versions of dBASE, now known as Visual dBASE from Inprise Corp. of Scotts Valley, Calif., formerly Borland International Corp.

The main unit 12 may optionally include or be connected to an user interface 26 containing, for example, one or more input and output devices to enable an operator to interface with the USR system 10. Illustrative input devices include a keyboard, keypad, track ball, mouse, pen and tablet, communication device, and data input devices such as voice and other audio and video capture devices. Illustrative output devices include cathode ray tube (CRT) displays, liquid crystal displays (LCD) and other video output devices, printers, communication devices such as modems, storage devices such as a disk or tape, and audio or video output devices. Optionally, the user interface 26 may be omitted, in which case the operator may communicate with the USR system 10 in a networked fashion via the communication port 14. It should be understood that the invention is not limited to any particular manner of interfacing an operator with the USR system.

It also should be understood that the invention is not limited to a particular computer platform, particular processor, or particular high-level programming language. Additionally, the computer system may be multiprocessor computer system or may include multiple computers connected over a computer network. It further should be understood that each module or step shown in the accompanying figures and the substeps or subparts shown in the remaining figures may correspond to separate modules of a computer program, or may be separate computer programs. Such modules may be operable on separate computers. The data produced by these components may be stored in a memory system or transmitted between computer systems.

Such a system may be implemented in software, hardware, or firmware, or any combination thereof. The various elements of the information system disclosed herein, either individually or in combination, may be implemented as a computer program product, such as USR software 18, tangibly embodied in a machine-readable storage device for execution by the computer processor 16. Various steps of the process may be performed by the computer processor 16 executing the program 18 tangibly embodied on a computer-readable medium to perform functions by operating on input and generating output. Computer programming languages suitable for implementing such a system include procedural programming languages, object-oriented programming languages, and combinations of the two.

As shown in FIG. 2, the computer system 10 may be connected to a plurality of interface centers 27 over a wide

area network **28**. The wide area network **28** may be formed from a plurality of dedicated connections between the interface centers **27** and the computer system **10**, or may take place, in whole or in part, over a public network such as the Internet. Communication between the interface centers **27** and the computer system **10** may take place according to any protocol, such as TCP/IP, ftp, OFX, or XML, and may include any desired level of interaction between the interface centers **27** and the computer system **10**. To enhance security, especially where communication takes place over a publicly accessible network such as the Internet, communications facilitating or relating to transmission of data from/to the USR database **24** or the computer system **10** may be encrypted using an encryption algorithm, such as PGP, DES, or other conventional symmetric or asymmetric encryption algorithm.

In one embodiment, the USR system **10** or USR database **24** may be able to authenticate its identity to a user or other entity accessing the system by providing an appropriate code which may be displayed on the user's smart card, for example a SecurID™ card or its equivalent, or other code generator, for example a single use code generator, being employed by the user. A comparison by the user or the code generator between the provided number and an expected number can validate, to the user (or other entity) or the code generator, that communication is with the database and not an imposter.

The database **24** shown in FIG. **1** has a USR database containing entries related to persons **1–n**. The data in the USR database may also be segregated, as shown in FIG. **4**, according to data type to enable individual computer modules to handle discrete applications on discrete data types. Segregating the data, as illustrated in FIG. **4**, may make access to the database more robust by enabling portions of the data in the USR database **24** to be accessible even when it is necessary to perform maintenance on a portion of the database. However, storing the data in the USR database **24** according to the scheme illustrated in FIG. **1** may make it easier for a user of the database to make changes to multiple types of data simultaneously or in a single session. There are advantages and disadvantages to each data structure, and the invention is not limited to a particular manner of organizing the data within the database **24**, data structures other than the two shown also being possible.

As shown in FIG. **3**, each entry **30** in the database **24** may contain multiple types of information. For example, in the embodiment shown in FIG. **3**, the entry contains validation information **32**, access information **34**, publicly available information **36**, address information **38**, credit card and other financial information **40**, medical information **42**, job application information **44**, and tax information **46**. The invention is not limited to a USR containing entries with all of this information or only this particular information, as any information on a person or other entity such as a company, institution, etc. may be stored in USR database **24**.

If the database information is split between multiple databases, each database will typically include at least the validation and access information to enable the USR software to correlate a validation attempt with a verified validation, and to enable the USR software to determine access privileges to the requested data. Alternatively, databases may be linked to permit information not in a main USR database to be retrieved, with validation/identification for all databases accessed being done at the USR system.

In FIG. **3**, the validation information is information about the user of the database to whom the data pertains and is to be used by the USR software **18** to validate that the person

attempting to access the information is the person to whom the data pertains or is otherwise authorized to receive it. The validation information may be any type of information that will reliably authenticate the identity of the individual.

In one embodiment, the user of the database will carry a SecurID™ card available from RSA Security, formerly Security Dynamics Technologies, Inc., of Cambridge, Mass. Use of this card enables secure access to the USR database without requiring the user to transmit any personal information. Specifically, to access the USR database, the card retrieves a secret user code and/or time varying value from memory and obtains from the user a secret personal identification code. The card mathematically combines these three numbers using a predetermined algorithm to generate a one-time unpredictable code which is transmitted to the computer system **10**. The computer system, specifically USR software **18**, utilizes the received one-time unpredictable code to determine if the user is authorized access to the USR database and grants access to the USR database if the user is determined to be authorized. The verification information **32** in the database entry in the embodiment of the invention illustrated in FIG. **3** contains information to enable the USR software **18** to validate the user using such a card in this manner.

Alternative types of identification cards or tokens may likewise be used. For example, other smart cards may be used which generate non-predictable single use codes, which may or may not be time varying, or other access code generators may be used. An algorithm generating such non-predictable codes may also be programmed onto a processor on a smart card or other computing device, such as a cell phone, pager, ID badge, wrist watch, computer, personal digital assistant, key fob, or other commonly available electronic device. For convenience, the term "electronic ID device" will be used generically to refer to any type of electronic device that may be used to obtain access to the USR database.

Likewise, various types of biometric information may be stored in the verification area of the database entry to enable the identity of the user possessing the identifying device to be verified at the point of use. Examples of the type of biometric information that may be used in this situation includes a personal identification number (PIN), fingerprint, voice print, signature, iris or facial scan, or DNA analysis. If desired, the verifying section of the database may contain a picture to be transmitted back to the person seeking to validate the device to ensure the person using the device is the correct person. Optionally, the identifying device itself may also be provided with a picture of the person authorized to use the card to provide a facial confirmation of the person's right to use the card.

In FIG. **3**, the Access information **34** is provided to enable different levels of security to attach to different types of information stored in the entry **30** in the USR database **14**. For example, the person may desire that their address information be made available only to certain classes of people, for example colleagues, friends, family, Federal Express, U.P.S., and the U.S. mail service. The names or universal identifiers for those selected individuals, companies, organizations and/or agencies may be entered into appropriate fields in the Access information to specify to the USR software **18** those individuals to whom the address information may be released. Likewise, access fields may be specified for the other types of information. For example, the individual may specify that only particular individuals and/or companies have access to the credit card and other financial information **40**, medical information **42**, job appli-

cation information **44** and tax information **46**. Additionally, the individual may specify that no one have access to that information unless the individual participates in the transaction (see FIG. 6).

As shown in FIG. 1, the USR software **18** contains algorithms for execution by the CPU **16** that enables the CPU **16** to perform the methods and functions of the USR software described below in connection with FIGS. 5–16. The USR software **18**, in this embodiment, performs all functions associated with validating an electronic ID card. If desired, a separate validation software module may be provided to validate electronic ID devices outside of a firewall segregating the validation information from other user information.

This algorithms comprising the USR software **18** may be used to implement, in one exemplary embodiment, a USR system configured to enable selected information to be disseminated to selected individuals in a secure and dynamic fashion. This information may be used for numerous purposes, several of which are set forth below and discussed in greater detail in connection with FIGS. 5–16.

For example, the USR system may be used to identify the person, enable the person to be contacted by telephone or mail anonymously, enable the person to be contacted by telephone or by mail without revealing the person's telephone number or present location, enable the person to purchase items over the Internet or in a store without revealing to the merchant any personal identification information or credit card information, enable the person to complete a job application without completing a job application form, enable the police to discern the person's identity and any outstanding warrants on the individual, and numerous other uses. The invention is not limited to these several enumerated uses, but rather extends to any use of the USR database. The methods of using the USR database **24** will now be discussed in connection with FIGS. 5–16.

FIG. 5 illustrates a method of training the USR database **24**. As shown in FIG. 5, the USR software **18** first validates the person's identification (**500**). The initial validation of the person's identification (**500**) may take place at the point of sale of an electronic ID device (for example, a smart card). This may be done in any conventional manner, such as by requiring the person to show a government issued identification card, passport, birth certificate, etc. Once the person's electronic ID device has been issued and initially validated, the validation process proceeds as discussed above.

After the validation process (**500**), the USR software **18** determines if the person has rights to enter data into the system (**502**). This step enables the system to charge persons for maintaining information in the USR database **24**. For example, the USR software **18** may poll a database of current accounts or a database of accounts that are currently in default to determine if the person has paid the access fee to enter data into the database. A similar account status inquiry process may be performed by the USR software **18** in connection with each of the other methods set forth in FIGS. 6–16. If the person is not authorized to enter data into the USR database **24**, the person is notified of the status of their account and the process returns (**512**) to wait for further input from another person. Alternatively, a person may be permitted to enter some classes of data into the system and update such classes of data at no charge, with a fee possibly being required for other classes of data, for example medical records. This would facilitate a more robust database.

If the person is authorized, the USR software **18** then enables the person to enter basic personal data into the USR database **24** (**504**). Optionally, personal data may be one

class of data the USR software **18** allows the person to enter into the USR database **18** regardless of account status, i.e., for free.

The USR software **18** will then check to see if the person has additional rights to enter additional data (**506**), such as data to be entered into one of the other categories of data in FIG. 3. Optionally, this step of checking the person's rights to enter data (**506**) may be combined with the initial check (**502**). If the person does not have rights to enter any further data, the USR software **18** notifies the user and returns (**512**).

If the USR software **18** determines that the person has the right to enter additional data into the USR database **24**, the person is prompted through the use of appropriate prompts, provided with forms, and otherwise enabled to enter advanced personal data into the USR database **24** (**508**). For each type of data entered, the person is asked to specify the type of access restrictions and/or whom should be allowed to access the advanced personal data (**510**). When the person has completed entering data into the database, the process returns (**512**) and commits the data to the database.

In the situation where only one person has access to enter and/or modify data for a given person in the database, there should be no conflict with committing data to the database. If, however, multiple people have access to a given account to modify data, the database may perform an integrity check to ensure the absence of conflict in the data before committing the new data to the database.

Enabling access to the information in the database will be explained in greater detail in connection with FIG. 6. As shown in FIG. 6, the database will generally allow anyone to access basic personal data on anyone without performing any authorization check (**600**).

If information beyond that specified in the basic personal information area is requested, the USR software **18** queries whether the requestor has the right to access the type of requested data (**602**). The process of determining the requestor's rights (**602**) typically involves validating the requestor's identity and correlating the identity, the requested information and the access information **34** provided by the person to the USR database during the training process described above with respect to FIG. 5.

If the USR software **18** determines that the requestor has rights to access the type of requested data (**604**), the USR software **18** instructs the USR database **24** to enable access to the type of requested data (**606**). The actual step of enabling access to the type of requested data may involve multiple steps of formulating a database query, querying the USR database **24**, retrieving the results, assembling the results into a user friendly or user readable format, and transmitting the information to the user.

If the USR software **18** determines that the requestor does not have the appropriate rights to access the type of requested data (**604**), the USR software **18** checks to see if the person is participating in the transaction (**608**). Checking to see if the person is participating in the transaction enables the user to authorize access to the requested data in real time. For example, a person may wish to participate in a transaction to give a potential employer one-time access to job application information **44** (see FIG. 3). If the person is not participating in the transaction, the USR software **18** determines that the requestor is not authorized to have access to the requested data, notifies the requester of this determination, and ends (**610**).

If the person is participating in the transaction (**608**), however, the USR software **18** validates the person's identity (**612**) and enables the person to change access rights to the data (**614**). If the USR software **18** is not able to validate

the person's identity, the USR software **18** refuses to allow the person to update the database, notifies the person and/or requester of this determination, and returns (**610**).

It is also possible that a person may be required to grant access to certain data, for example financial data such as account numbers, under duress. The system may provide the person with the ability to safely signal this when accessing the system by using a selected access code or by making a known modification to the access code provided by the electronic ID device. On receiving such code, the system would take appropriate steps to protect the person, including for example alerting the police, tracking the person's location to the extent possible, providing traceable data, and the like.

Once the person has had the opportunity to change access rights to the data (**614**), the USR software **18** again checks to see if the requester has rights to access the type of requested data (**616**). Although step **616** may seem redundant, given the fact that the person is participating in the transaction and has just previously changed access rights to the database to enable the requester to have access to the data, step **616** is actually useful at preventing a different type of fraud. Specifically, the requester may not be forthright with the person regarding the type of information they are requesting. If step **616** were omitted, the USR software **18** may inadvertently allow access to an unauthorized type of information in the situation where the requester has surreptitiously requested multiple types of data.

If the USR software **18** determines that the requester has rights to the type of data requested (**616**), it causes the USR database to enable access to the type of requested data (**606**). Otherwise, it notifies the requestor of the decision to deny access to the requested data and returns (**610**).

Various applications of the USR database **24** and USR software **18** will now be discussed in connection with FIGS. **7-16**. These applications are merely exemplary of the types of applications enabled by the USR software **18** and USR database **24**, and the invention is not limited to these particular applications.

FIG. **7** illustrates one embodiment of a method of using the USR software **18** and USR database **24** to purchase goods or services from a merchant without revealing to the merchant account information relating to the person's bank or credit card.

As shown in FIG. **7**, when a user initiates a purchase (**700**), the user enters a secret code in the user's electronic ID device (**702**) to cause the ID device to generate a one-time code or other appropriate code, and presents the electronic ID device with the code to the merchant or otherwise presents the code to the merchant. The merchant transmits to the credit card company (1) the code from the electronic ID device, (2) the store number, (3) the amount of the purchase (**704**), and the time of receipt of the code. The credit card company takes this information and passes the code from the electronic ID device to the USR software **18** (**706**). The USR software **18** determines if the code is valid, or was valid at the time offered, and if valid accesses the user's credit card information and transmits the appropriate credit card number to the credit card company (**708**). While the link between the USR system and the credit card system is a secure link, there is always a danger that the link may be penetrated and credit card numbers obtained. This may be avoided by instead transmitting, on approval, a multidigit public ID code for the credit card holder which the credit card company can map to the correct credit card number. Even if the link is violated, the public ID code is of no value and the secure link prevents this code from being improperly

sent to the credit card company. The credit card company checks the credit worthiness of the user and declines the card or debits the user's account in accordance with its standard transaction processing system (**710**). The credit card company then notifies the merchant of the result of the transaction (**712**). In this embodiment, the user has been able to purchase goods or services from a merchant without ever providing to the merchant the credit card number. Since the electronic ID device generates a time variant code or otherwise generates a code that can for example only be used for a single transaction, the merchant retains no information from the transaction that may be fraudulently used in subsequent transactions.

Another embodiment of a system for facilitating purchase of goods or services without providing financial information to the merchant is set forth in FIG. **8**. In FIG. **8**, like FIG. **7**, the user initiates a purchase (**800**), enters a secret code in the electronic ID device (**802**) and presents the resultant code to the merchant. The merchant, in this embodiment, transmits to the USR software **18**, (1) the code from the electronic ID, (2) the store number, and (3) the amount of the purchase (**804**). The USR software **18** determines if the code is valid (**806**) and, if valid, accesses from the USR database **24** the user's credit card information (**808**). The USR software then transmits to the credit card company (1) the credit card number, (2) the store number, and (3) the amount of purchase (**808**). The information in this embodiment transmitted to the credit card company is intended to be in a format recognizable to the credit card company. Accordingly, the invention is not limited to transferring from the USR system **10** to the credit card company the enumerated information, but rather encompasses any transfer of information that will enable the use of the USR system **10** to appear transparent to the credit card company.

The credit card company then processes the transaction in a standard fashion, such as by checking the credit worthiness of the person, declining the card or debiting the user's account and transferring money to the merchant's account (**810**). The credit card company then notifies the USR system **10** the result of the transaction (**812**) and the USR software **18** in turn notifies the merchant of the result of the transaction (**814**).

In this embodiment, like the embodiment of FIG. **7**, the user can use the USR system **10** to purchase goods or services from a merchant without providing the merchant with the user's credit card number. In the embodiment of FIG. **8**, the interposition of the USR system **10** between the merchant and the credit card company is transparent to the credit card company and thus requires no or minimal cooperation from the credit card company to implement.

FIG. **9** illustrates one embodiment of a method of using the USR system **10** to verify funds when using a check to purchase goods or services from a merchant. In the embodiment of FIG. **9**, the user initiates a purchase and writes a check to the merchant (**900**). The check may be a conventional check containing identifying information, or may be a check bearing a unique serial number and no identifying information to enable the check to be used anonymously.

In either situation, the user enters a secret code into the electronic ID card and presents the resulting code to the merchant along with the check (**902**). The merchant transmits to the USR software **18** (1) the code from the electronic ID card, (2) the store number, and (3) the amount of the purchase (**904**). Where the check is an anonymous check, the merchant also transmits to the USR software **18** the check number.

13

The USR software **18** then determines if the code from the electronic ID is valid (**906**), and if valid accesses the user's bank information and transmits to the bank: (1) the user's bank account number, (2) the store number, and (3) the amount of the purchase. (**908**). Optionally, the USR software **18** may additionally inform the bank of the check number.

The bank polls its own database to determine if there are sufficient funds in the user's account (**910**) and notifies the USR software **18** of the result (**912**). The USR software **18** then, in turn, notifies the merchant of the result of the verification (**914**).

This check verification system may take place over an unsecured connection between the merchant and the USR system **10** since the user's bank account information is not sent over the connection between the merchant and the USR system **10**. Moreover, where an anonymous check is used, the merchant is not even provided with the person's name or account information in written form. This provides additional security against unauthorized persons writing subsequent checks.

The check verification system may be conducted over a telephone network, such as by having the merchant call a toll free number, or over a network connection such as over the Internet.

FIG. **10** illustrates a method of conducting a transaction with a merchant without requiring the user to provide to the merchant the user's name, address, or other identifying information, while enabling the merchant to ship the goods to the user. This may be beneficially employed, for example, in connection with transactions that take place between remote parties in a networked environment, such as the Internet.

As shown in FIG. **10**, the user initiates an anonymous purchase by entering a secret code into the electronic ID device and transmitting the result to the on-line merchant (**1000**). The merchant transmits this information to the USR software **18**, along with the store number and the amount of the purchase (**1002**). Optionally, the merchant may provide the store number and purchase price to the user and the user may send this information directly to the USR software **18** along with the code from the electronic ID. Where the number from the electronic ID device is a time varying number, the merchant may also need to input the time the number was received. Alternatively, the electronic ID device may encode or encrypt the time with the number, the USR software being able to extract time when receiving the number from the merchant. This may not be required where the time varying number varies slowly, for example changing every hour rather than every minute as for some existing such devices.

In either event, the USR software **18** determines if the code is valid (**1004**) and, if valid, accesses the user's credit card information from the USR database **24** (**1006**). The USR software **18** then contacts the user's credit card company, as described above in connection with FIG. **8** (**1008**) and notifies the USR software **18** of the result (**1000**).

If the user's credit is declined, the USR software **18** notifies the on-line merchant and the transaction is terminated (**1012**). If the user's credit is honored, the USR software **18** polls the USR database **24** for the user's address and/or address code (**1014**). Address codes are discussed below in greater detail with reference to FIG. **11**. The merchant then packages the goods into a parcel, labels the parcel with the appropriate address and/or address code and ships the parcel to the user (**1016**). Having the USR system **10** provide the address and/or address code to the on-line merchant enables the user to purchase items in a networked

14

environment without requiring the user to input address information in connection with every sale.

FIG. **11** illustrates an use of the USR database **24** to deliver mail to a user without requiring the user to provide address information to the sender. This may be useful in many contexts. For example, the user may wish that the address information be known only by the post office. In this instance, using the USR database **24** according to the method of the invention described below, will enable the user to receive parcels without requiring the user to provide the merchant with the address information. Additionally, the user's address may change, temporarily, permanently, or frequently. Enabling the sender to send mail by entering a code instead of an address enables the post office to effectively deliver the coded mail to the corresponding address regardless of the frequency with which the address changes or the duration in which the address will remain valid.

In FIG. **11**, the user provides an address code on a public area of the USR database **24** that is available to all persons to see (**1100**). This code may for example be six alpha characters, which should be adequate for currently anticipated system populations. Optionally, the user may provide this code directly to a merchant or other person desirous of sending the person one or more parcels.

The user also provides address information to the address information area **38** of the user's entry in the USR database **24** (**1102**). Access to the address information **38** is restricted by a rule or other appropriate entry in the access information **34** of the user's entry to only permit mail, parcel or other material delivery services, such as the US mail, UPS and Fed Ex to access the address information.

When someone wishes to have a parcel or other items delivered to the user, the sender retrieves the user's address code from the USR database **24** or otherwise receives the address code from the user, and prints the address code on the parcel (**1104**).

The delivery service accesses the USR software **18**, validates its identity, and queries the USR database **24** for address information corresponding to the address code (**1106**). The USR database **24** retrieves the appropriate address data and provides the address information to the delivery service. The delivery service then either prints out an address label, prints a machine readable bar code to be attached to the package, or correlates an entry in a delivery database between the address code and the user address (**1110**). The delivery service then uses this retrieved information to deliver the package to the user while never supplying the merchant with the user's permanent or temporary address. A user may also assure that mail, parcels, etc. are delivered to a current location by providing only a single notice to the USR system, regardless of how frequently the person moves. The person can also automatically provide for address changes where the person moves according to a known schedule. Thus, deliveries to be made on a weekday could be directed to one address and deliveries on a weekend to another address; or deliveries during winter months to one address and during summer months to a different address.

FIG. **12** illustrates a method of enabling a person to telephone a user of the USR system **10** without providing the user's telephone number to the person. In the embodiment illustrated in FIG. **12**, the user provides a telephone code on the publicly available area of his entry on the USR database **24** (**1200**). This code may be assigned by the USR software **18** or made up by the user. The user also provides the USR database **24** with actual telephone information to enable the USR system **10** to connect callers with the user (**1202**).

15

The person wishing to telephone the user of the USR system **10** calls a telephone number and enters the telephone code of the user (**1204**). The USR software **18**, optionally, may require the person to identify themselves to see if they are authorized to call the user. Assuming that the person is authorized to call the user, or if no authorization check is performed, the USR connects the person to the telephone number in the USR database **24** without providing the person with the telephone number.

Enabling the user to specify the telephone number may be advantageous for many reasons. First, the user may frequently be switching between telephone coverage areas and may wish to be reachable at all times. Simply by instructing the USR database **24** to connect incoming telephone calls to one of a myriad of numbers will facilitate connecting the incoming calls to, for example, the user's cell phone, work phone, pager, car phone or home phone, without necessitating the user to provide all these numbers to the caller. A similar system may be implemented for facsimile transmissions, e-mails or other communications.

The user also may have predefined rules to enable telephone calls to follow a set pattern. For example, the user may desire to receive telephone calls only from family members during the night time at home, may wish to have all incoming calls routed to a car phone during commuting hours, and may wish to have all incoming calls routed to a cell phone during lunch. These time dependent rules may and/or caller specific rules may be entered into the USR database to specify accessibility and connectivity of incoming telephone calls.

The publicly available address code and telephone code and any other codes may be the same, or may be different, there being some advantages to having a single code usable for all such applications for each person on the system. The codes could be accessible through a variety of media including telephone and the internet. Where two or more people on the system have the same name, which will frequently be the case, additional publicly available biographical data may be provided with the name to assure that the right code is selected. The system may similarly be used to provide public keys for use in a public key/private key encryption system, to provide other public codes for an individual or to provide other public information. Access to such information would typically be unrestricted.

Where the system is used to provide public keys, the public code used to obtain the key, or possibly the public key itself, may be used as above to obtain the e-mail address, telephone number or the like for the person to whom the message is being sent, and the USR system may also be used to perform the encryption. When the recipient receives the message, he deencrypts it using the recipient's private key in standard fashion, including deencrypting the name of the sender. However, this does not necessarily verify the sender and such verification may be desirable for important messages, particularly ones involving large financial transactions. The USR system may accomplish such verification by also storing private keys for people in the system. The sender first authenticates himself to the system, and the system then adds a second signature to the message which is encrypted with the sender's private key. The receiving party deencrypts this signature with the sender's public key. Since the system only sends such signatures for authenticated users, the message is thus verified.

FIG. **13** illustrates a general method of using the USR database **24** to authenticate a user's identification. This may be used in connection with any of the other methods

16

disclosed herein to ensure that the electronic ID device has not been stolen and/or hacked by an unauthorized holder.

Specifically, in the embodiment illustrated in FIG. **13**, the user attempts to prove identification to a validator, such as to prove that the possessor of the electronic ID device is of sufficient age to purchase alcohol (**1300**). In connection with this attempt, the user enters a secret code into the electronic ID (**1302**). The validator transmits to the USR software **18** the code from the electronic ID (**1304**). If the USR software **18** determines that the code is valid (**1306**), it accesses the user's photograph, age information, or any other desired information, and transmits that information to the validator (**1308**). By transmitting back to the validator a picture of the person to whom the electronic ID card was issued, the validator can ensure that the person using the electronic ID card is the proper person. Likewise, the validator can ensure, based on the information provided by the USR system **10**, that the person is as old as the person claims to be.

A specific embodiment of this identification validation procedure is illustrated in FIG. **14**. In FIG. **14**, a policeman takes the place of the validator. In this scenario, however, instead of simply transmitting to the policeman a validation of the user's identity, such as their picture, the policeman may also receive additional information, such as the user's police records, records of any arrests, outstanding warrants, and other similar information that may be of use to the policeman when determining how to handle a particular individual.

FIG. **15** illustrates a process for enabling the user to provide specific information to a party, such as medical staff in an emergency room. As shown in FIG. **15**, if the user desires to provide information to a party (**1500**), the user enters a secret code in the electronic ID device and provides the electronic ID code to the party (**1502**). The party transmits to the USR software **18** the ID code and the party code (**1504**). The party code may be a code from for example an electronic device which identifies the party, may be a status code which identifies the class of users to which the party belongs, for example policeman, emergency room personnel, doctor, etc. or may be a combination of both, the status code for example being encrypted into the ID code. The USR software **18** determines if the code is valid (**1506**), accesses the user's information in the USR database **24** and transmits available information to the party (**1508**). In this scenario, the user may be provided with a plurality of different codes to enter into the electronic ID device depending on the type of information to be released to the party. For example, the user's basic code may be 1234. The fifth digit of the electronic code may specify the type of information to be provided, i.e., 1=address information, 2=medical information; 3=telephone information, 4=job application information, etc. Using multiple codes eliminates any ambiguity about the authority provided by the user to the party, but requires the user to remember additional information.

The above assumes the user is able to provide an ID code when the information is required. However, in for example an emergency room situation, the user may not be in a position to provide the ID code, but would still want medical records provided. The release authorization for certain portions of the users database could therefore specify that the information be released to certain class or classes of individuals and the USR system would release such information to individuals or organizations based only on status code. Thus, the status code of an emergency room could alone trigger release of medical data.

FIG. **16** illustrates one embodiment of a method of using the USR database **24** to complete a standard application,



such as a job application or an application to rent an apartment. This embodiment is a specific example of the more generic method of enabling a party to retrieve information discussed above with respect to FIG. 15. In FIG. 16, however, the party may be provided with the opportunity to provide a form to the USR software 18, the fields of which may be automatically completed with information from the job application information section of the USR database 24.

As can be seen from the above, many of the users of the USR system are organizations or agencies such as carriers (post office, UPS, FedEx), communication companies, law enforcement organizations, hospitals and other medical facilities and the like. Each of these organizations can be provided with specialized software either on a disc or other suitable media or electronically, for example over the internet, which performs a number of functions, for example automatically generating status codes for data access requests, controlling information received, and formatting data received in response to a request in a desired way. This can result in an access request from such organization for a given user causing all data on the user required to complete the form being retrieved and presented to the organization in the format of their form. A user may also authorize an organization for which a form has been completed using the USR system to receive updates, either in response to a request from the organization or at selected intervals, for example once a year, so as to maintain information in the forms current. Since the user will be providing information to the system on a regular basis, this is a relatively easy and painless way for the user to maintain current information with many organizations the user deals with.

Another potential use of the system is to permit a person to be located where only limited biographical information on the person is known. Users of the USR system wishing to participate in this feature could be cued to provide non-confidential biographical data when they come on the system or at any time thereafter when they decide to participate. They can also indicate whether they wish their name given out in response to such an inquiry or to merely be alerted to an inquiry which might involve them and information on the requester. A person seeking to find another person or group of people can input appropriate biographical data, for example members of 1975 Harvard University hockey team, or information of a persons last known address plus school information, etc. The system will then provide a list of persons who meet the listed criteria from which the person making the inquiry can hopefully find the person they are looking for.

In the above application and others, when a person is located, the person may request that only the persons address code or general access code (ie a single code which is used to get current address, telephone, e-mail, etc. information) be provided when the person is located. This can further protect the individual from undesired contacts.

FIG. 17 illustrates another embodiment of the invention. As shown in FIG. 17, the USR system 10 may be used to secure expensive personal equipment, such as stereos, televisions, laptop computers, cellular telephones, cars, boats, and other items of value to a person. In this embodiment, each item to be secured using the USR system is provided with a USR timer chip imbedded in the electronics. If the USR timer chip is not provided with a code within a predefined period of time, for example every 30 days, the equipment is deactivated. Thus, for example, a television, mobile phone, laptop computer, automobile, heavy equipment, weapon or facility may be provided with a security chip having an internal timer that must be reset before

expiration by provision of a particular code. When reset does not occur, the timer will disable the electronic device or other device using any one of a number of known disablement methods. Exemplary codes may be transmitted in the same manner as beeper signals are conventionally transmitted or may be transmitted to wired devices over the Internet or other public network.

The USR system 10 may be advantageously employed to automatically provide the secured property with the necessary codes at appropriate intervals, unless instructed by the user of the USR system 10 to cease doing so. Alternatively, the USR system 10 may require participation by the user prior to sending out the activation codes.

In this embodiment, the user may provide to the USR system 10, information indicative of the codes to be transmitted, timing information, and automation information—i.e., whether the codes should be sent automatically or should require user intervention. Optionally, where the user opts to require user intervention, the USR system 10 may notify the user of the upcoming deadline via e-mail or another method.

This system may be useful to secure sensitive equipment other than personal equipment as well, such as military equipment, public equipment, school equipment and any other equipment that is subject to theft.

It should be understood that various changes and modifications of the embodiments shown in the drawings and described in the specification may be made within the spirit and scope of the present invention. Accordingly, it is intended that all matter contained in the above description and shown in the accompanying drawings be interpreted in an illustrative and not in a limiting sense. The invention is limited only as defined in the following claims and the equivalents thereto.

What is claimed is:

1. A secure registry system including:

a database containing selected data on each of a plurality of entities, a code being stored with at least selected portions of said data for at least selected said entities restricting access to said selected portions to entities defined by each said code;

a processor coupled to the database;

an identity mechanism which permits each entity to securely identify itself to the system;

an input mechanism which determines if an identified entity is authorized to enter data into the database, and permits an authorized entity to enter data into the database;

an access mechanism which permits access requests to be made to said database, each such request including an indication of data requested and at least one of a coded indication of an entity requesting the access and the status of such entity;

an entitlement mechanism, including at least in part said identity mechanism, which determines from at least one of provided coded indication of entity and coded indication of entity status whether an entity is entitled to access the requested data, the mechanism granting access to the requested data if an entity is entitled and denying access if an entity is not entitled; and

a restriction mechanism which permits entities to identify portions of the data relating to them for which there is to be restricted access and to store an appropriate code with each such portion, said restriction mechanism including a change mechanism for permitting an entity



19

identified by said identity mechanism to change entities to whom access is granted for at least selected portions of the data for an entity.

2. A system as claimed in claim 1 wherein each entity has a code regimen by which it can be identified by said identity mechanism and a distress code regimen which each entity may employ when making at least one of entries and changes in the database to indicate that such is being done under duress; and

a protection mechanism operative in response to receipt of a distress code regimen for initiating appropriate action for the protection of each entity.

3. A system as claimed in claim 1 wherein said entitlement mechanism releases selected portions of data for entities to at least selected classes of data requesters based only on the coded status of such entity.

4. A system as claimed in claim 3 wherein at least selected data requesting entities have a mechanism included in their processors which automatically adds their status code to each data request sent by an entity to the system.

5. A system as claimed in claim 3 wherein at least selected data requesting entities have a mechanism included in their processors which provides a format for requested data; and wherein said system includes a mechanism which accumulates data required to respond to a request in said format and responds to the request with the collected data presented in said format.

6. A system as claimed in claim 1 wherein said coded indication and coded status for an entity are selectively merged into a single coded input to the system for an access requesting entity, the system including a mechanism for determining the coded status and coded indication from the single coded input.

7. A system as claimed in claim 1 wherein an entity requesting data has a mechanism included in their processor which automatically includes with at least selected data requests a coded status indication and a form into which requested information is to be provided; and

wherein said entitlement mechanism provides information from the database to which an entity is entitled in the form provided by an entity.

8. A system as claimed in claim 1 wherein relevant data is stored in additional databases outside said system; said system including a retrieval mechanism which, if an entity is entitled to receive such data, retrieves relevant data from a said additional database and provides it to an entity requesting the data in a manner transparent to an entity.

20

9. A method for providing a secure registry system including a database containing selected data on each of a plurality of entities, a code being stored with at least selected portions of said data for at least selected said entities restricting access to said selected portions to entities defined by each said code, the method comprising;

permitting each entity to securely identify itself, determining if an identified entity is authorized to enter data into the database, and permitting an authorized entity to enter data into the database;

permitting access requests to be made to said database, each such request including an indication of data requested and at least one of a coded indication of an entity requesting the access and the status of such entity;

determining from at least one of provided coded indication of entity and coded indication of entity status whether an entity is entitled to access the requested data, and granting access to the requested data if an entity is entitled and access being denied if an entity is not entitled; and

permitting entities to identify portions of the data relating to them for which there is to be restricted access and to store an appropriate code with each such portion, said act of permitting further comprising permitting an entity to change entities to whom access is granted for at least selected portions of the data for an entity.

10. The method as claimed in claim 9 wherein each entity has a code regimen by which it can be identified and a distress code regimen which each entity may employ when making at least one of entries and changes in the database to indicate that such is being done under duress further comprising in response to receipt of a distress code regimen, initiating appropriate action for the protection of each entity.

11. The method as claimed in claim 9, further comprising releasing selected portions of data for entities to at least selected classes of data requesters based only on the coded status of such entity.

12. The method as claimed in claim 9 wherein relevant data is also stored in additional databases outside said system, the method further comprising:

if an entity is entitled to receive such data, retrieving relevant data from a said additional database and providing it to the entity requesting the data in a manner transparent to an entity.

\* \* \* \* \*