



US007805372B2

(12) **United States Patent**
Weiss

(10) **Patent No.:** **US 7,805,372 B2**
(45) **Date of Patent:** **Sep. 28, 2010**

- (54) **UNIVERSAL SECURE REGISTRY** 5,023,908 A 6/1991 Weiss
- (76) Inventor: **Kenneth P. Weiss**, 59 Sargent St.,
Newton, MA (US) 02458 5,058,161 A 10/1991 Weiss
5,097,505 A 3/1992 Weiss

(*) Notice: Subject to any disclaimer, the term of this patent is extended or adjusted under 35 U.S.C. 154(b) by 672 days. (Continued)

(21) Appl. No.: **11/760,729** EP 0986209 3/2000
(22) Filed: **Jun. 8, 2007** (Continued)

(65) **Prior Publication Data** OTHER PUBLICATIONS
US 2007/0289000 A1 Dec. 13, 2007

Related U.S. Application Data
(63) Continuation of application No. 11/677,490, filed on Feb. 21, 2007.
(60) Provisional application No. 60/775,046, filed on Feb. 21, 2006, provisional application No. 60/812,279, filed on Jun. 9, 2006, provisional application No. 60/859,235, filed on Nov. 15, 2006.

(51) **Int. Cl.**
G06Q 20/00 (2006.01)
G06F 7/04 (2006.01)
G06F 15/16 (2006.01)
G06F 17/30 (2006.01)
H04L 29/06 (2006.01)

(52) **U.S. Cl.** **705/51**; 713/182; 726/4;
726/5; 726/8

(58) **Field of Classification Search** 705/51;
726/4-5, 8
See application file for complete search history.

(56) **References Cited**
U.S. PATENT DOCUMENTS

- 4,720,860 A 1/1988 Weiss
- 4,856,062 A 8/1989 Weiss
- 4,885,778 A 12/1989 Weiss
- 4,998,279 A 3/1991 Weiss

FOREIGN PATENT DOCUMENTS

EP 0986209 3/2000

(Continued)

OTHER PUBLICATIONS

Pabrai, U. "Biometrics for PC-User Authentication: A Primer" Feb. 1, 2001. Access Controls & Security Systems. All pages. <http://www.securitysolutions.com/mag/security_biometrics_pcuser_authentication/index.html>.*

(Continued)

Primary Examiner—Evens J Augustin
Assistant Examiner—Calvin K Cheung
(74) *Attorney, Agent, or Firm*—Lando & Anastasi, LLP

(57) **ABSTRACT**

A method and system for controlling access to a plurality of secure computer networks using a secure registry system is disclosed. The secure registry system includes a database containing selected data of a plurality of users each authorized to access at least one of the plurality of secure computer networks. The method and system facilitate receiving authentication information from an entity at a secure computer network, communicating the authentication information to the secure registry system, validating the authentication information at the secure registry system, receiving from the secure registry system an indication of whether the entity is authorized to access the secure computer network, and granting the entity access to the secure computer network when the authentication information of the entity corresponds to one of the plurality of users.

29 Claims, 28 Drawing Sheets

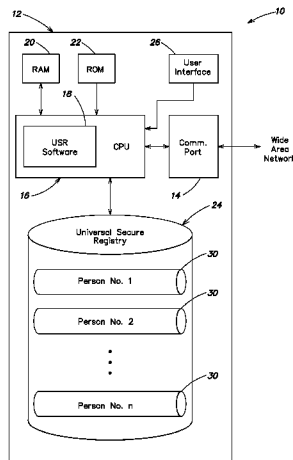

U.S. PATENT DOCUMENTS

5,168,520	A	12/1992	Weiss	
5,237,614	A	8/1993	Weiss	
5,361,062	A	11/1994	Weiss	
5,367,572	A	11/1994	Weiss	
5,398,285	A	3/1995	Borgelt et al.	
5,479,512	A	12/1995	Weiss	
5,485,519	A	1/1996	Weiss	
5,657,388	A	8/1997	Weiss	
5,664,109	A	9/1997	Johnson et al.	
5,813,006	A	9/1998	Polnerow et al.	
5,915,023	A	6/1999	Bernstein	
6,073,106	A	6/2000	Rozen et al.	
6,130,621	A	10/2000	Weiss	
6,253,202	B1	6/2001	Gilmour	
6,253,203	B1	6/2001	O'Flaherty et al.	
6,260,039	B1	7/2001	Schneck et al.	
6,308,203	B1	10/2001	Itabashi et al.	
6,309,342	B1	10/2001	Blazey et al.	
6,393,421	B1	5/2002	Paglin	
6,516,315	B1	2/2003	Gupta	
6,546,005	B1	4/2003	Berkley et al.	
6,581,059	B1	6/2003	Barrett et al.	
6,640,211	B1	10/2003	Holden	
6,658,400	B2	12/2003	Perell et al.	
6,819,219	B1	11/2004	Bolle et al.	
6,845,448	B1	1/2005	Chaganti et al.	
6,941,271	B1	9/2005	Soong	
7,237,117	B2	6/2007	Weiss	
7,278,026	B2 *	10/2007	McGowan	713/186
7,489,781	B2	2/2009	Klassen et al.	
7,502,459	B1 *	3/2009	Moseley	379/265.02
7,548,981	B1	6/2009	Taylor et al.	
7,657,639	B2 *	2/2010	Hinton	709/229
2001/0032100	A1	10/2001	Mahmud et al.	
2001/0044900	A1	11/2001	Uchida	
2002/0046061	A1	4/2002	Wright et al.	
2002/0176610	A1	11/2002	Okazaki et al.	
2002/0178364	A1	11/2002	Weiss	
2003/0115490	A1	6/2003	Russo	
2003/0123713	A1	7/2003	Geng	
2003/0129965	A1	7/2003	Siegel	
2003/0163710	A1	8/2003	Ortiz et al.	
2003/0226041	A1	12/2003	Palmer	
2004/0017934	A1 *	1/2004	Kocher	382/125
2004/0034771	A1	2/2004	Edgett	
2004/0059923	A1	3/2004	ShamRao	
2004/0111625	A1	6/2004	Duffy et al.	
2004/0117215	A1	6/2004	Marchosky	
2004/0133787	A1	7/2004	Doughty	

2004/0188519	A1	9/2004	Cassone	
2005/0001711	A1	1/2005	Doughty et al.	
2005/0039027	A1	2/2005	Shapiro	
2005/0187843	A1	8/2005	Lapsley et al.	
2005/0210270	A1	9/2005	Rohatgi et al.	
2005/0235148	A1 *	10/2005	Scheidt et al.	713/168
2006/0016884	A1	1/2006	Block et al.	
2006/0122939	A1	6/2006	Cohen et al.	
2006/0165060	A1	7/2006	Dua	
2007/0040017	A1	2/2007	Kozlay	
2007/0079136	A1	4/2007	Vishik et al.	
2007/0124597	A1	5/2007	Bedingfield, Sr.	
2007/0198436	A1	8/2007	Weiss	
2008/0021997	A1 *	1/2008	Hinton	709/225
2009/0175507	A1	7/2009	Schaffner	

FOREIGN PATENT DOCUMENTS

EP	1081632	3/2001
GB	2 382 006 A	5/2003
WO	9636934	11/1996
WO	0214985	2/2002

OTHER PUBLICATIONS

"Information Security: Challenges in Using Biometrics" Sep. 9, 2003. All pages. <<http://www.gao.gov/new.items/d031137t.pdf>>.*

Huntington, G. "101 Things to Know About Single Sign On." 2006. Authentication World. All pages. <<http://www.authenticationworld.com/Single-Sign-On-Authentication/101ThingsToKnowAboutSingleSignOn.pdf>>.*

"Single Sign On Authentication" Mar. 13, 2007. Authentication World. All pages. Retrieved Jul. 9, 2010 via Wayback Machine. <<http://web.archive.org/web/20070313200434/http://www.authenticationworld.com/Single-Sign-On-Authentication/>>.*

"FIPS PUB 46-3." Oct. 25, 1999. National Institute of Science and Technology (NIST). All pages.

"PGP: An Introduction to Cryptography." 2000. All pages. International Search Report from corresponding PCT/US2007/070701 mailed Mar. 11, 2008.

Kessler, G. "An Overview of Cryptography." 22 Aug. 22, 2002. All pages. Retrived via Wayback Machine on Jan. 19, 2010. <http://www.garykessler.net/library/crypto.html>.

International Search Report from related PCT Application No. PCT/US2007/004646, mailed Nov. 27, 2007.

International Search Report from related PCT Application No. PCT/US2009/035282, mailed Jul. 10, 2009.

Treasury Board of Canada Secretariat, PKI for Beginners Glossary, <http://www.tbs-sct.gc.ca/pki-icp/beginners/glossary-eng.asp>, Jul. 19, 2005.

* cited by examiner

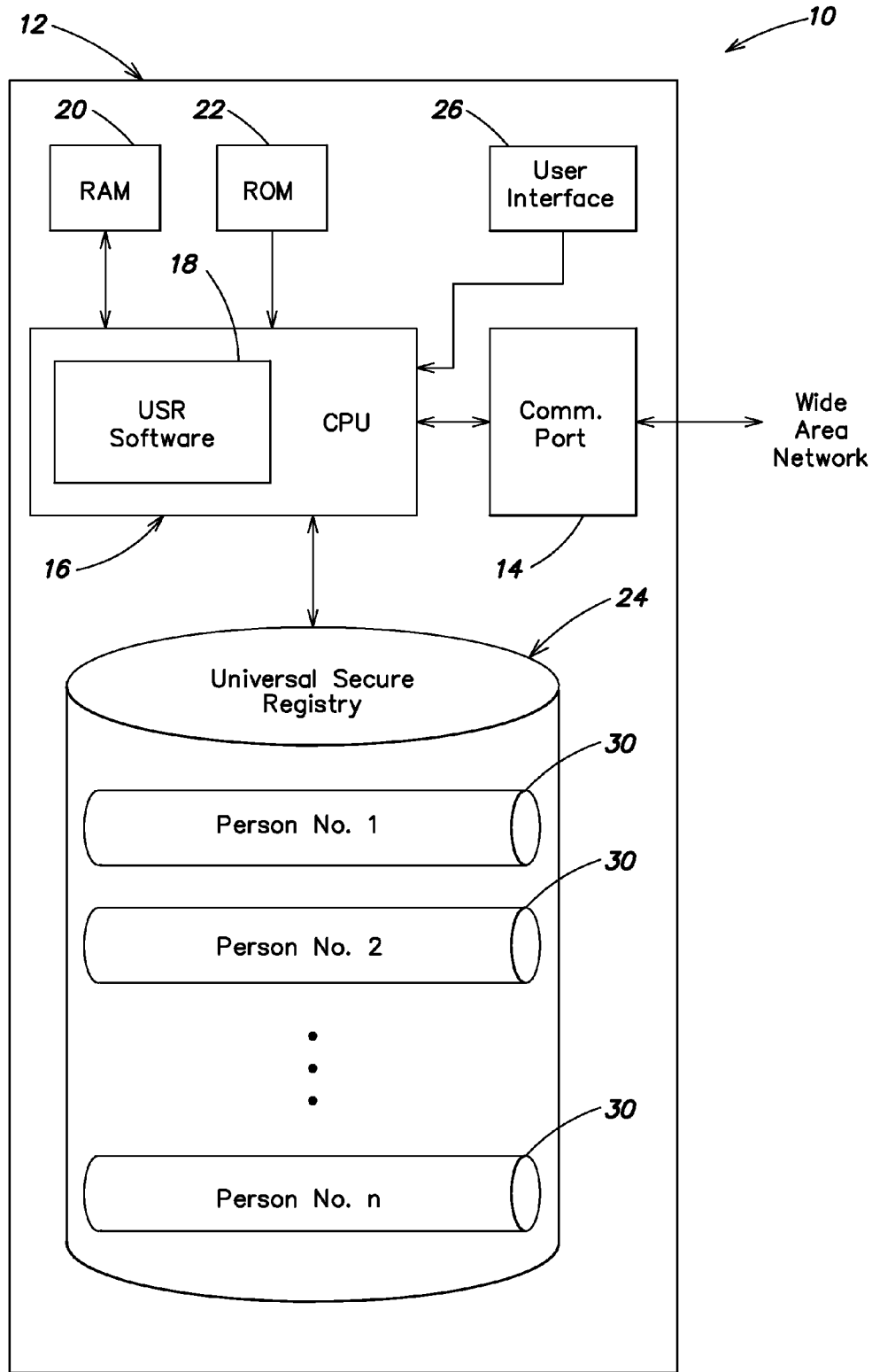

FIG. 1

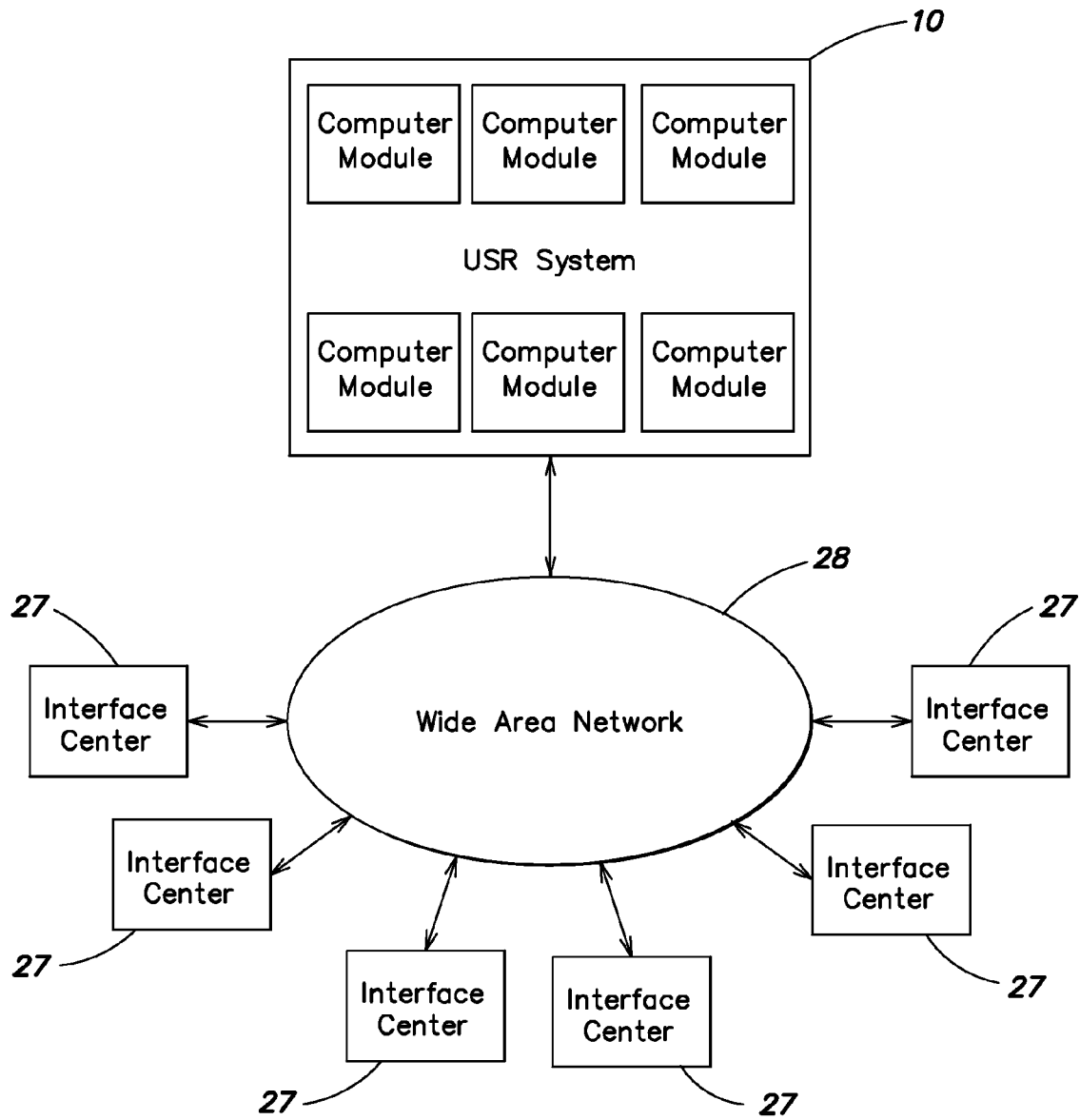

FIG. 2

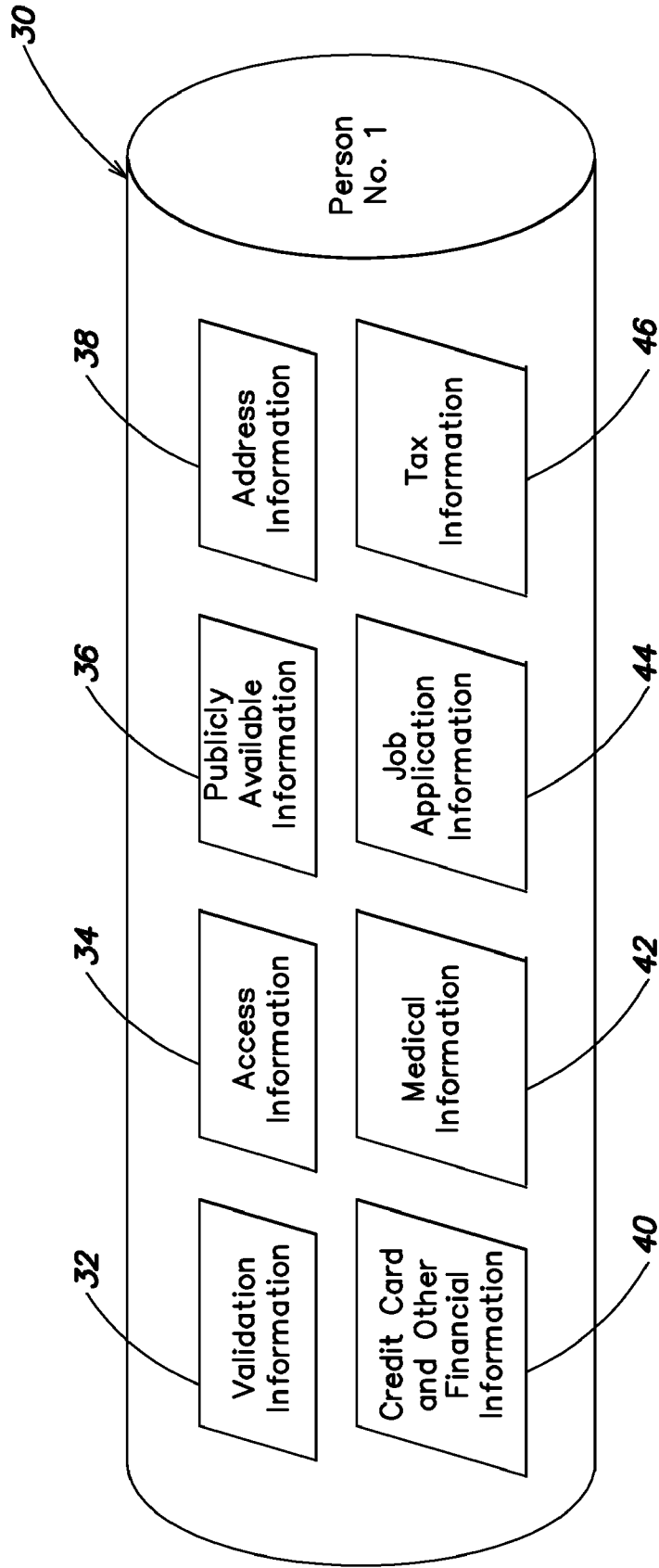

FIG. 3

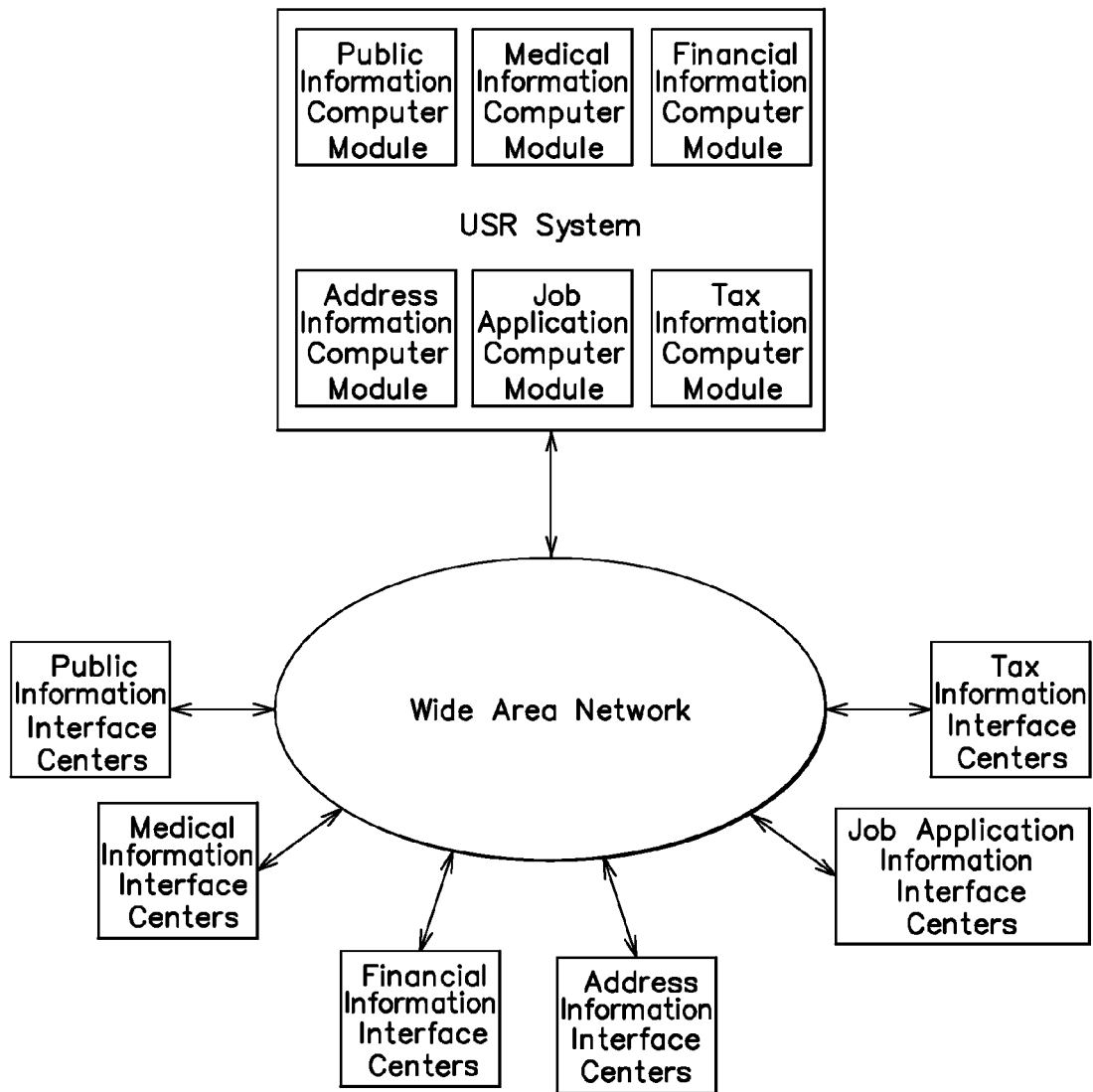

FIG. 4

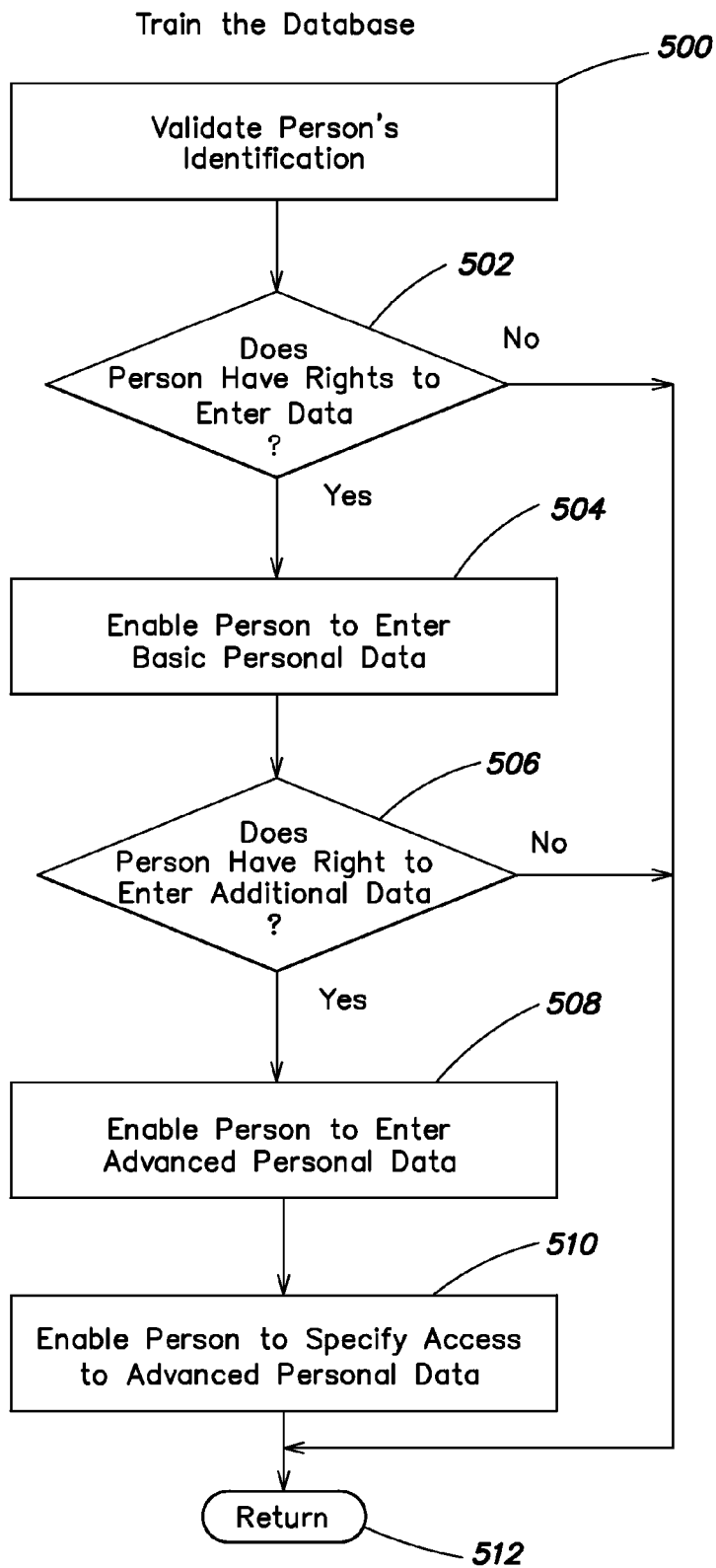

FIG. 5

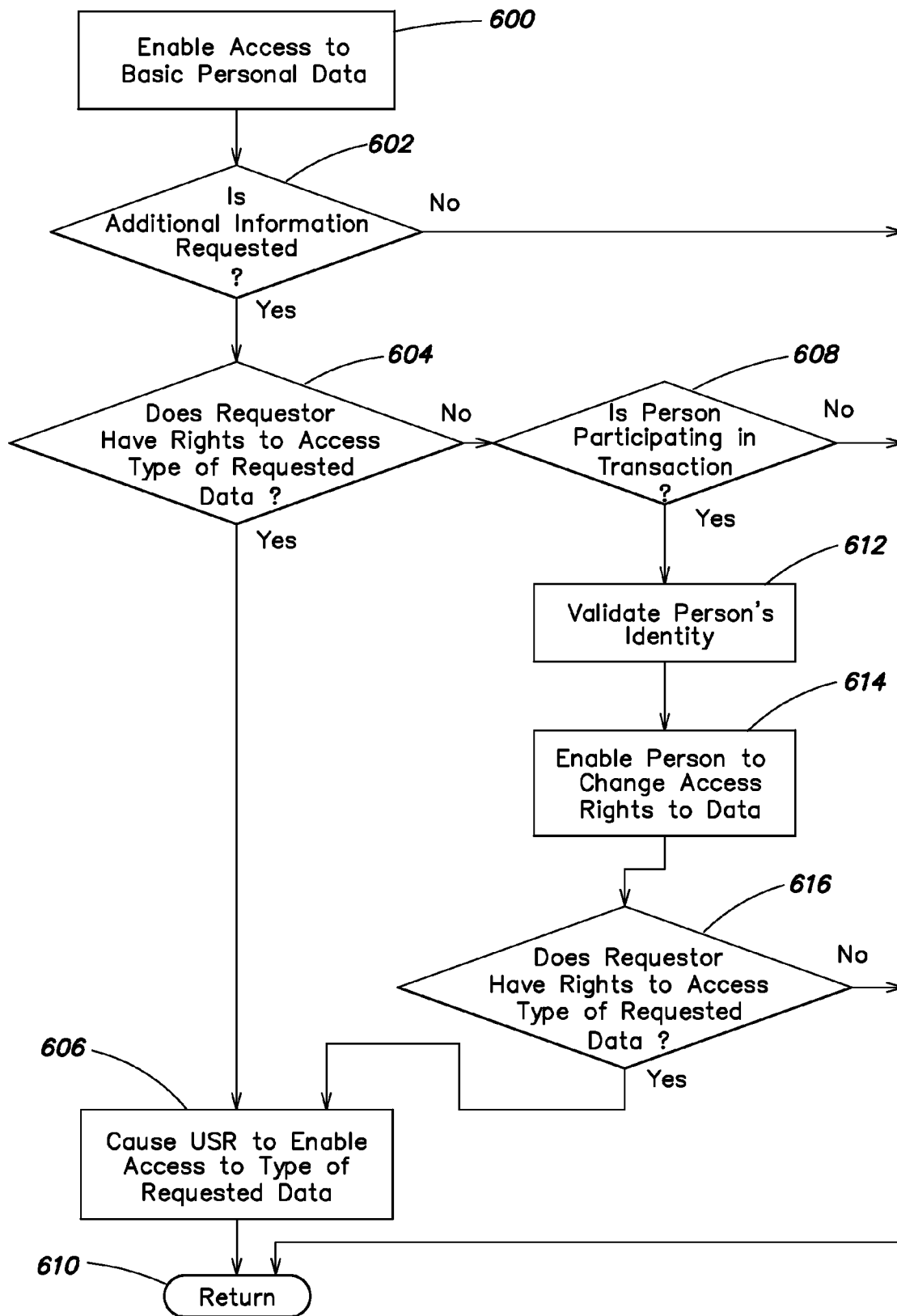

FIG. 6

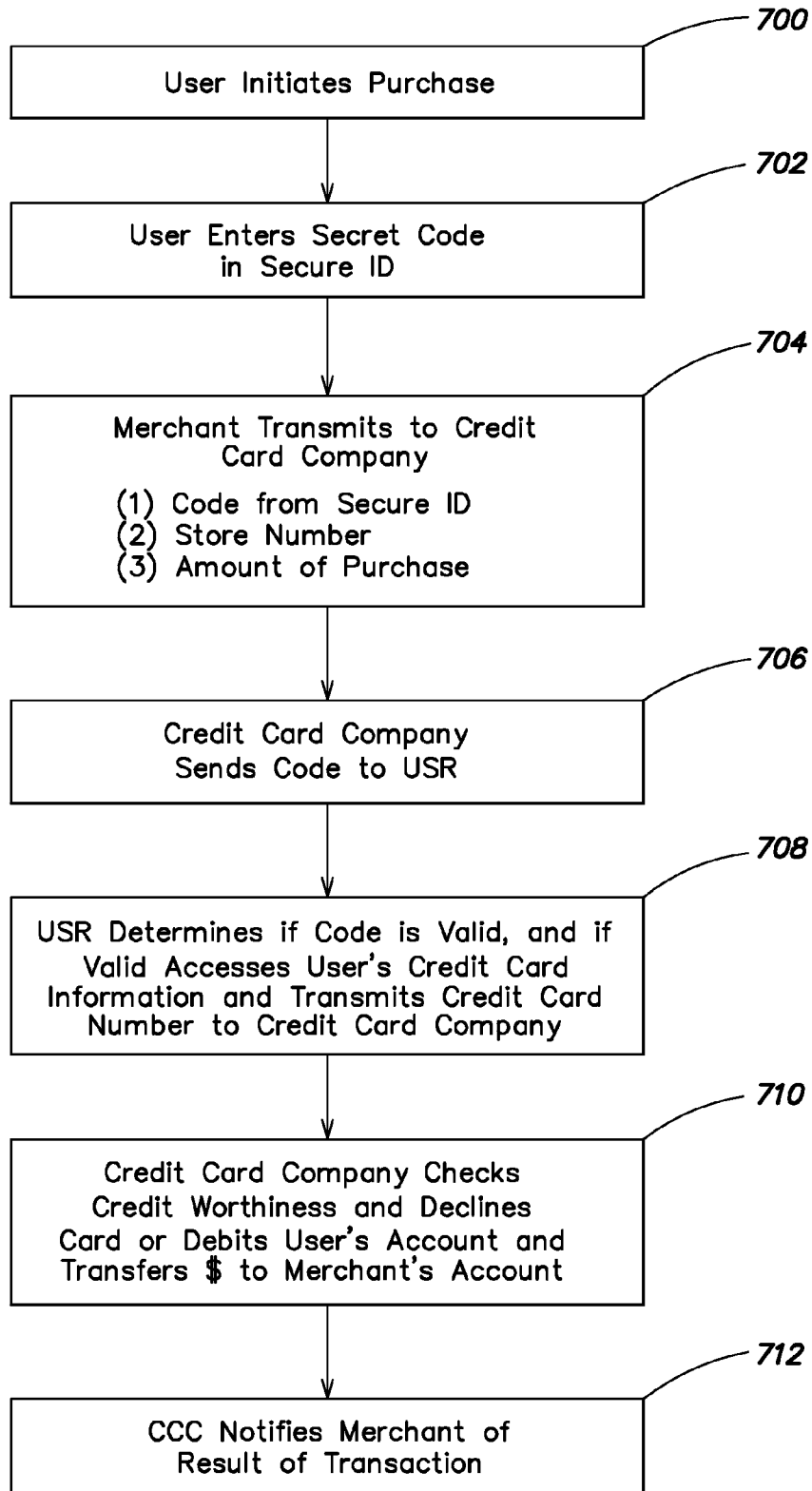

FIG. 7

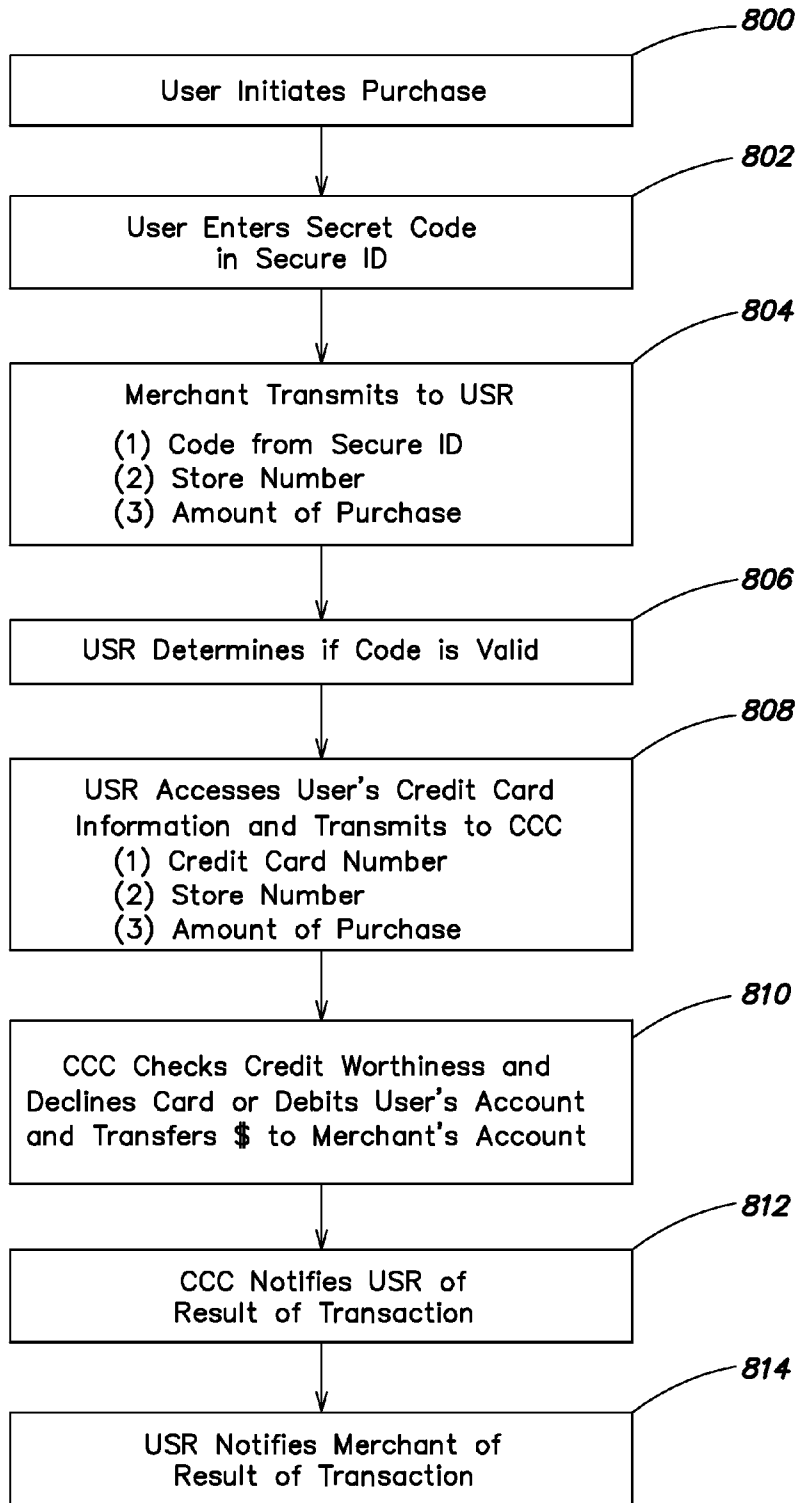

FIG. 8

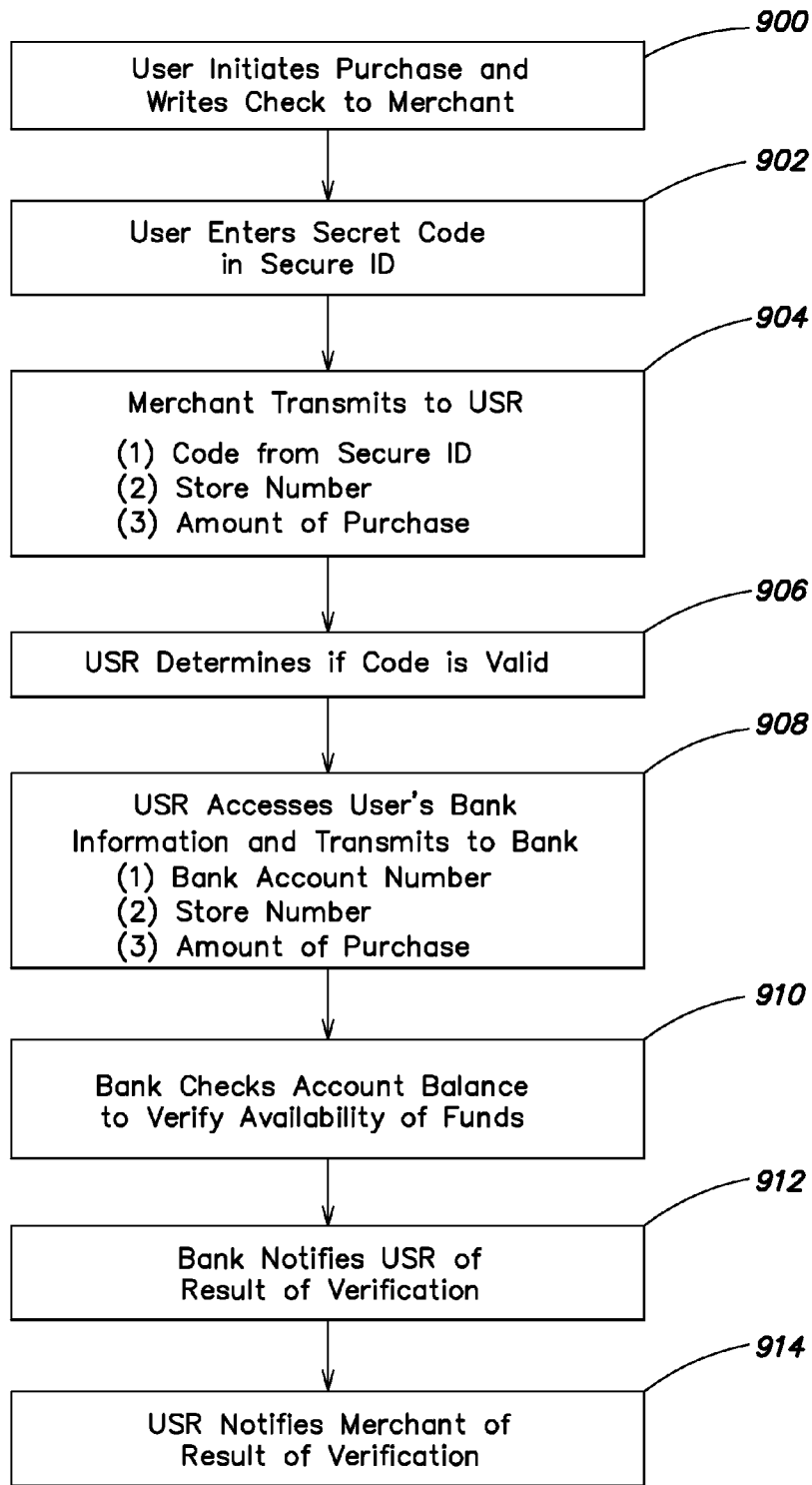

FIG. 9

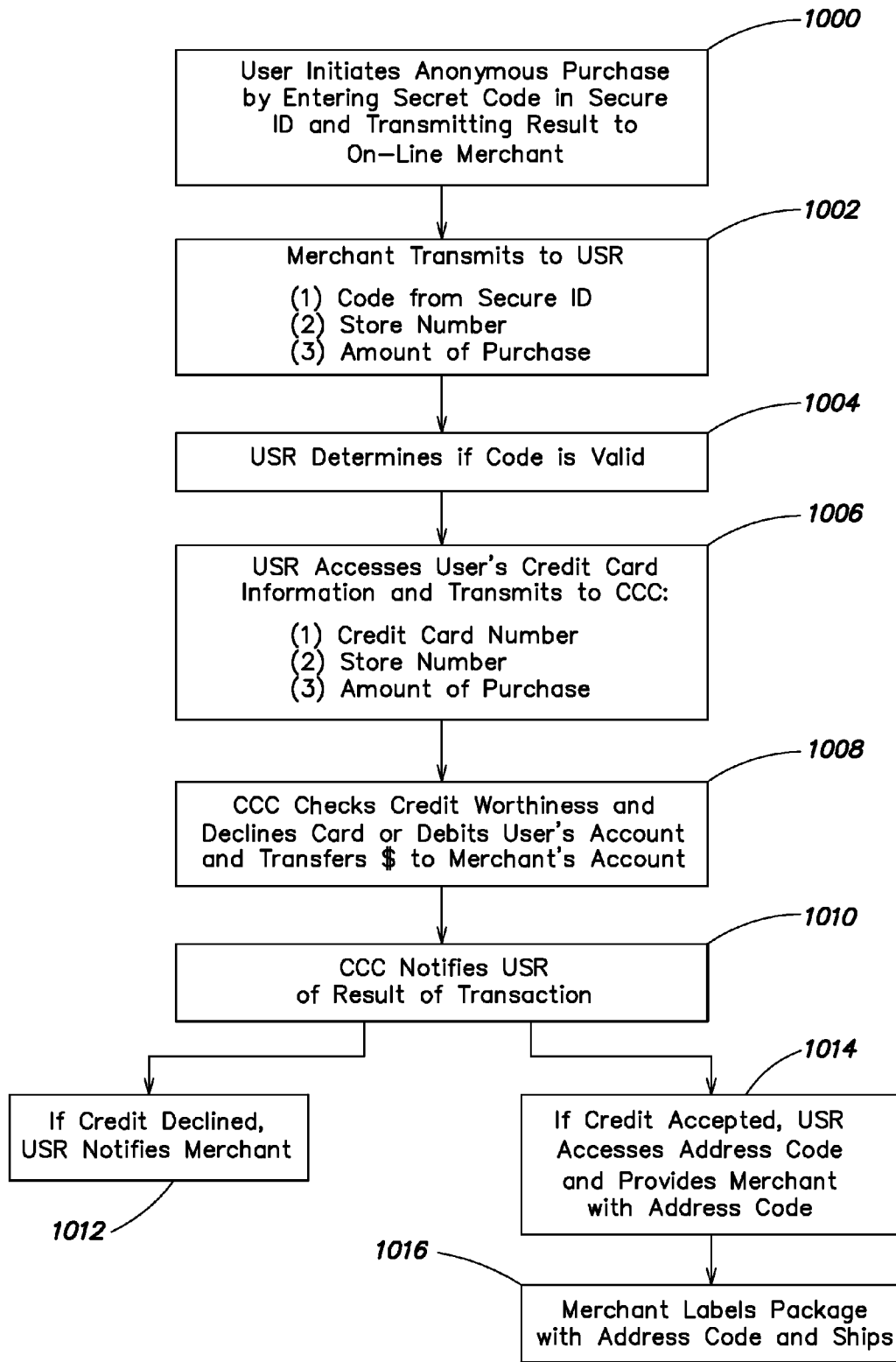

FIG. 10

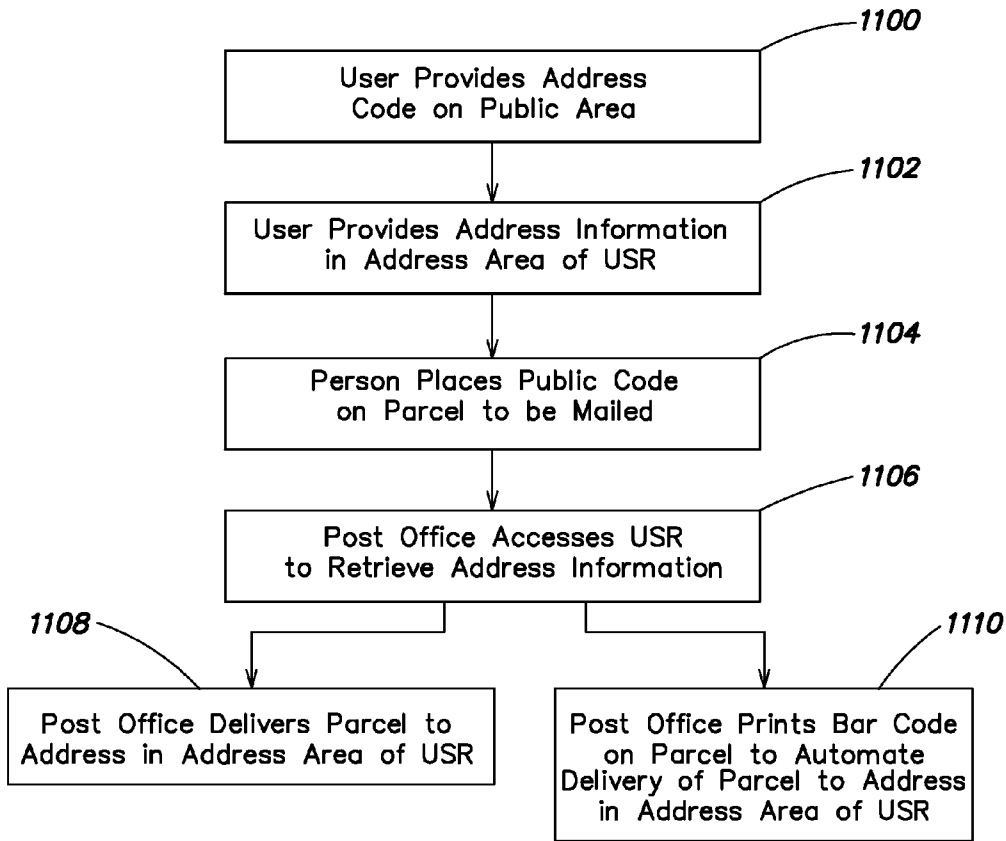

FIG. 11

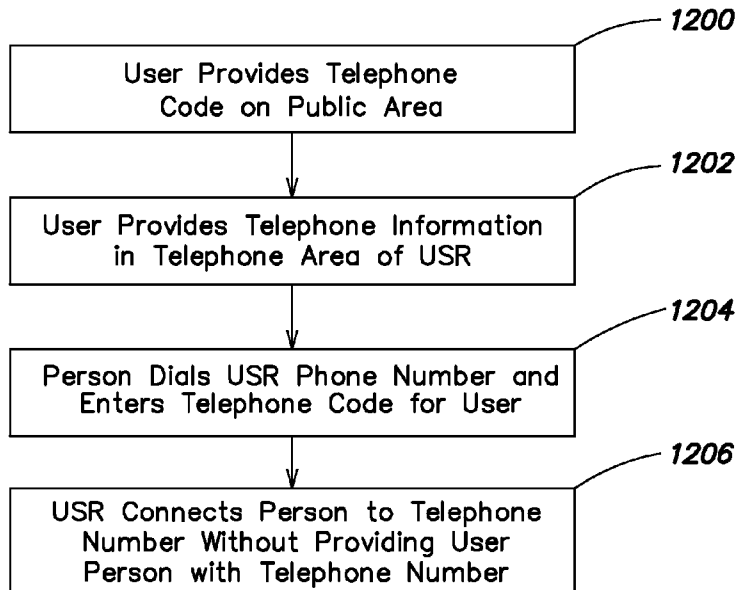

FIG. 12

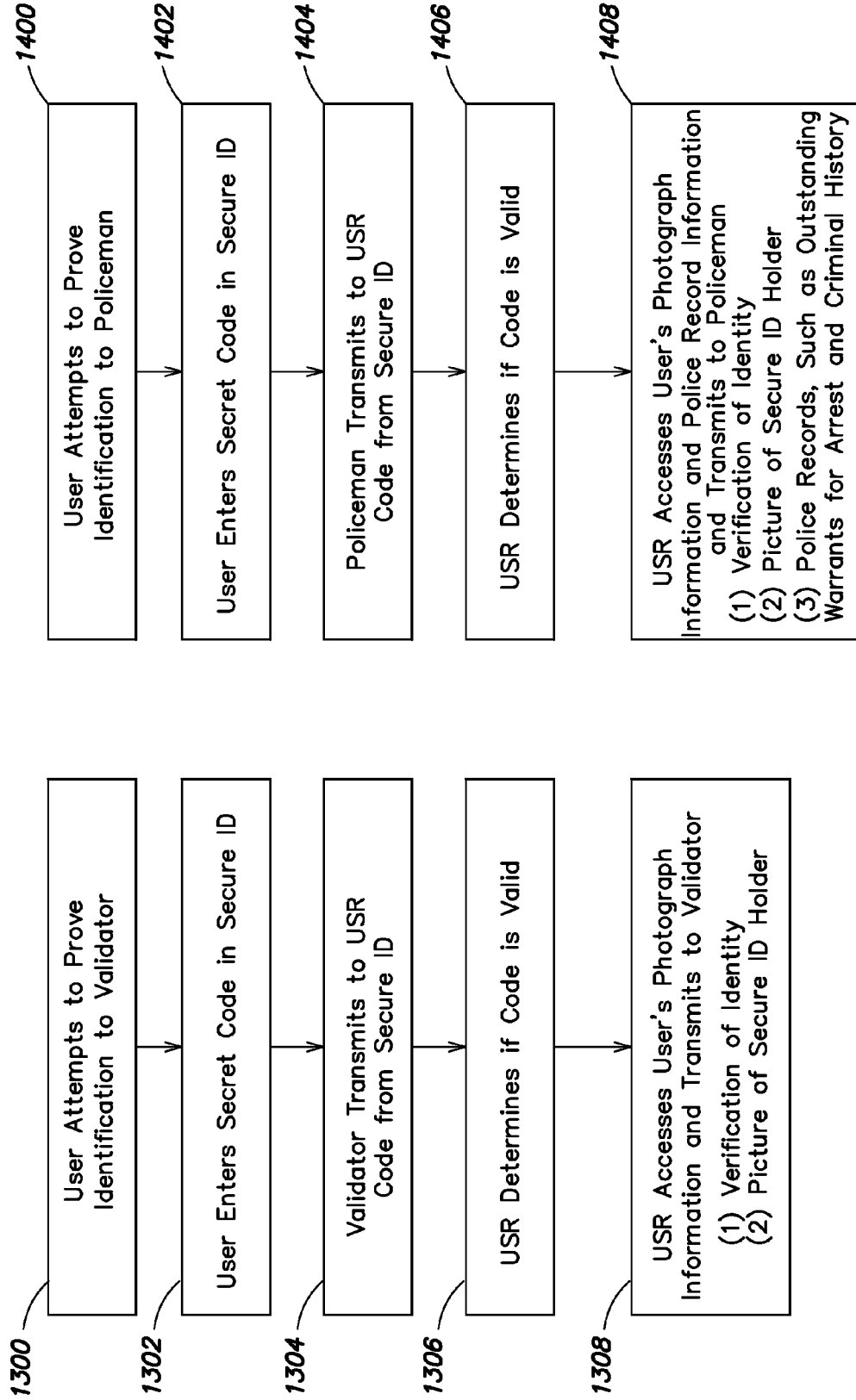

FIG. 13

FIG. 14

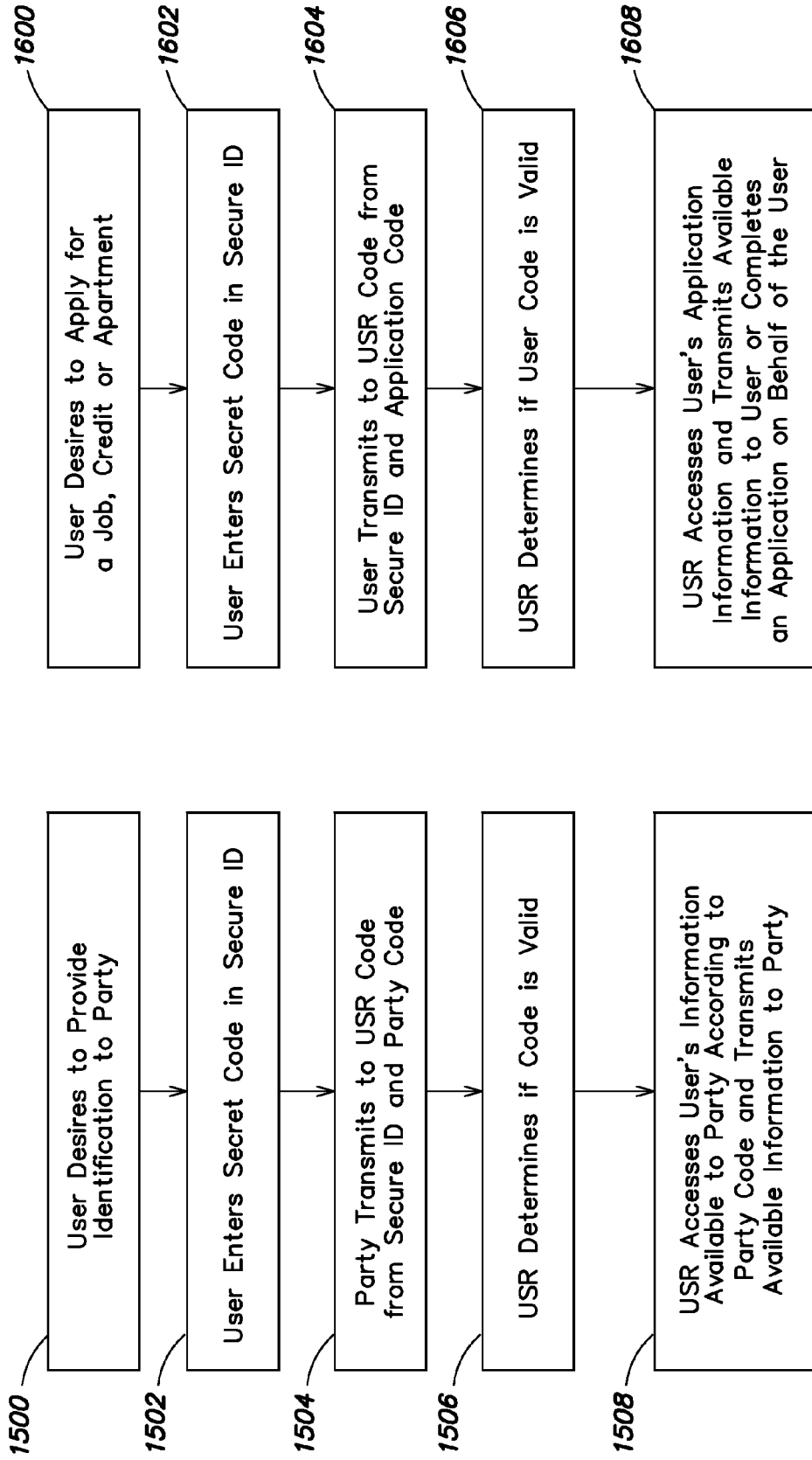

FIG. 15

FIG. 16

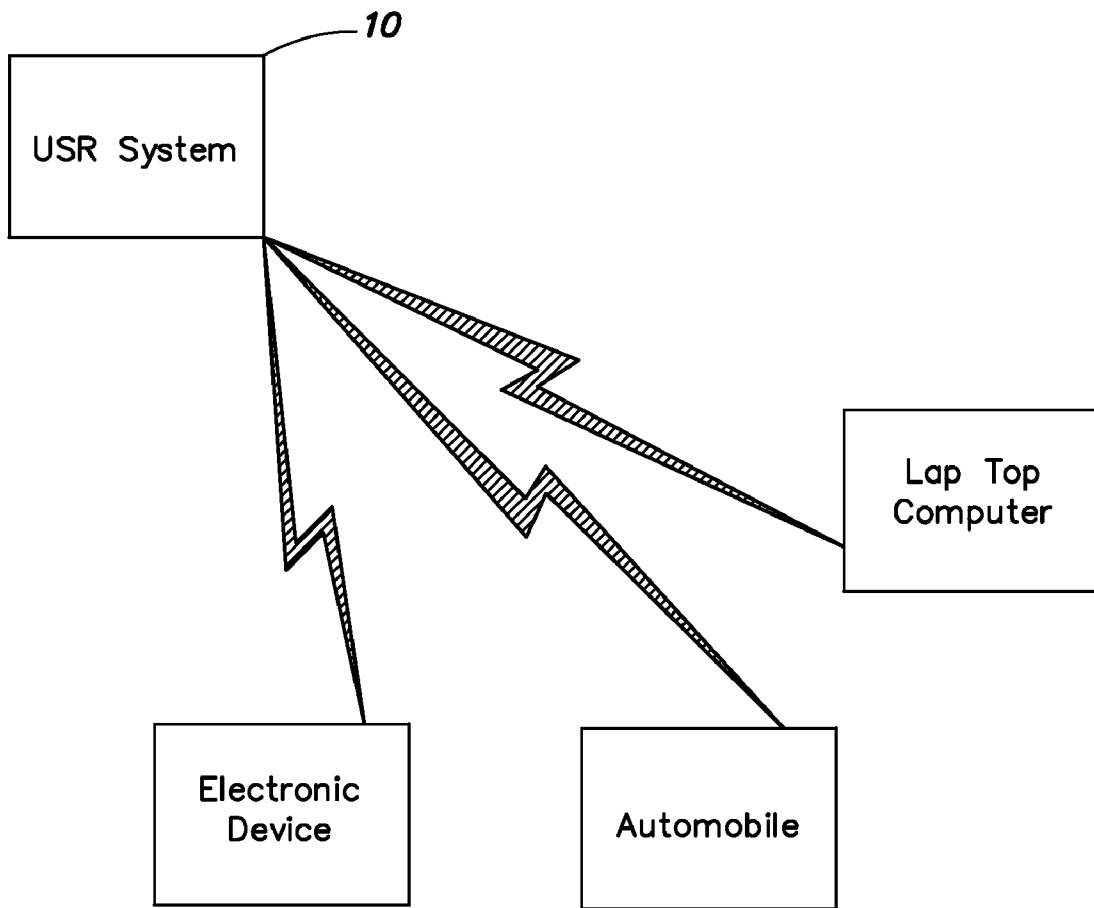

FIG. 17

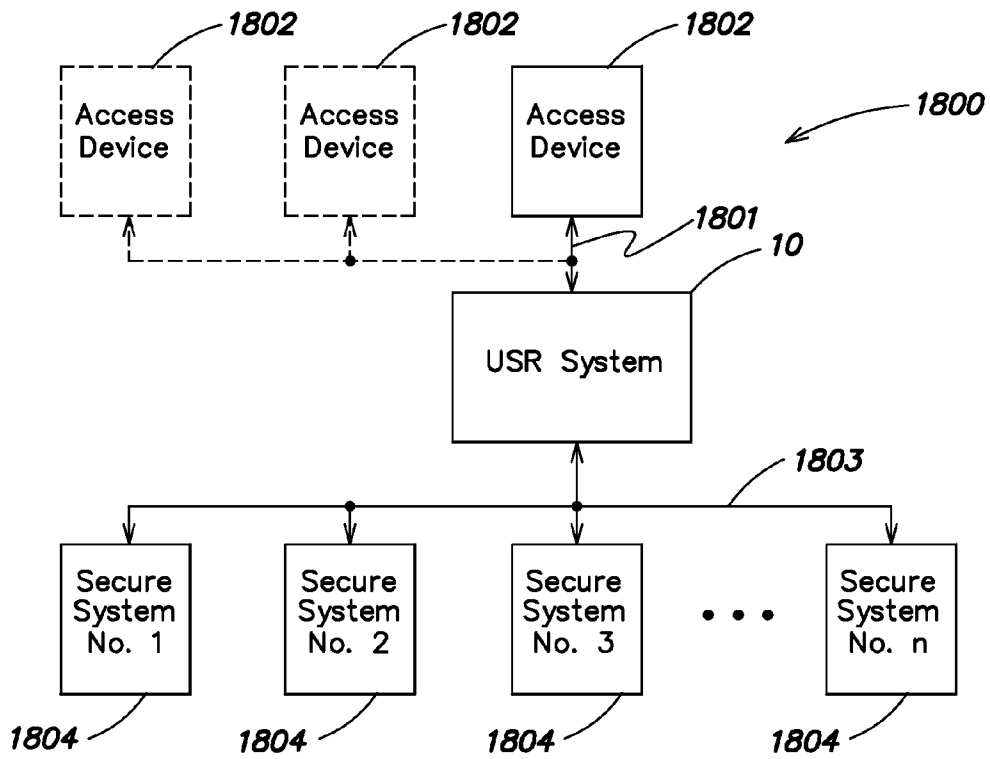

FIG. 18A

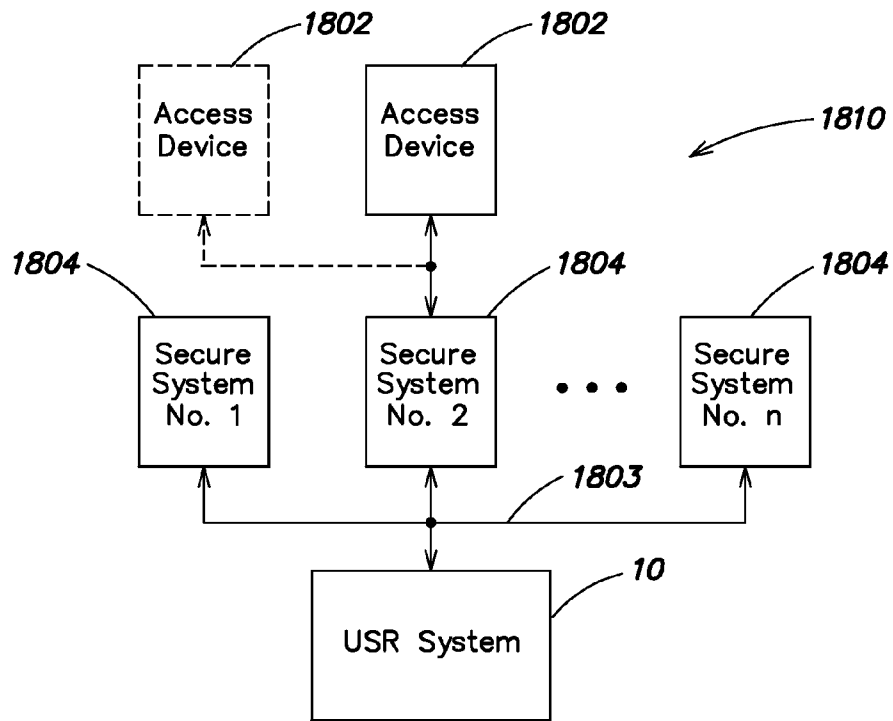

FIG. 18B

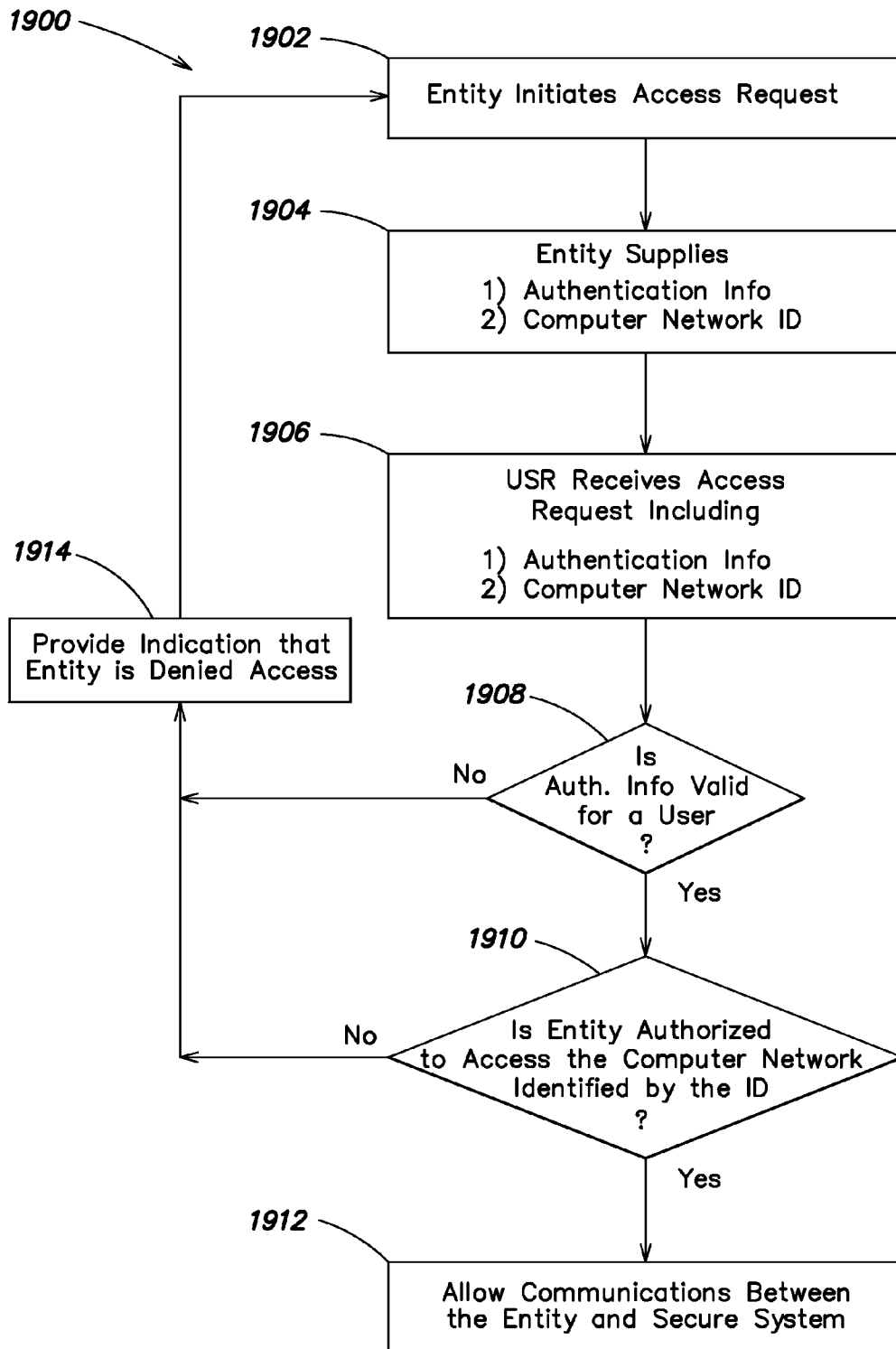

FIG. 19

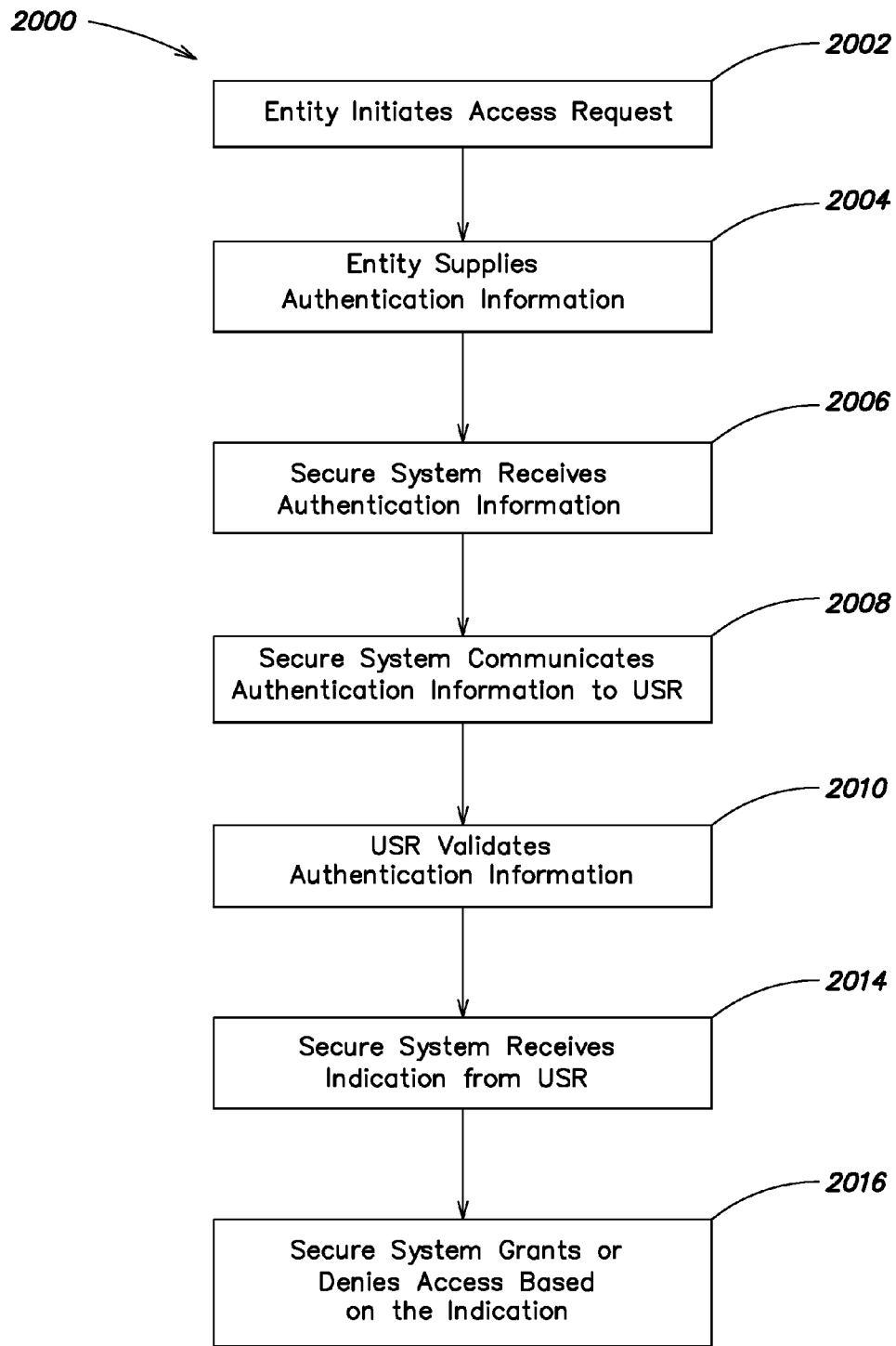

FIG. 20

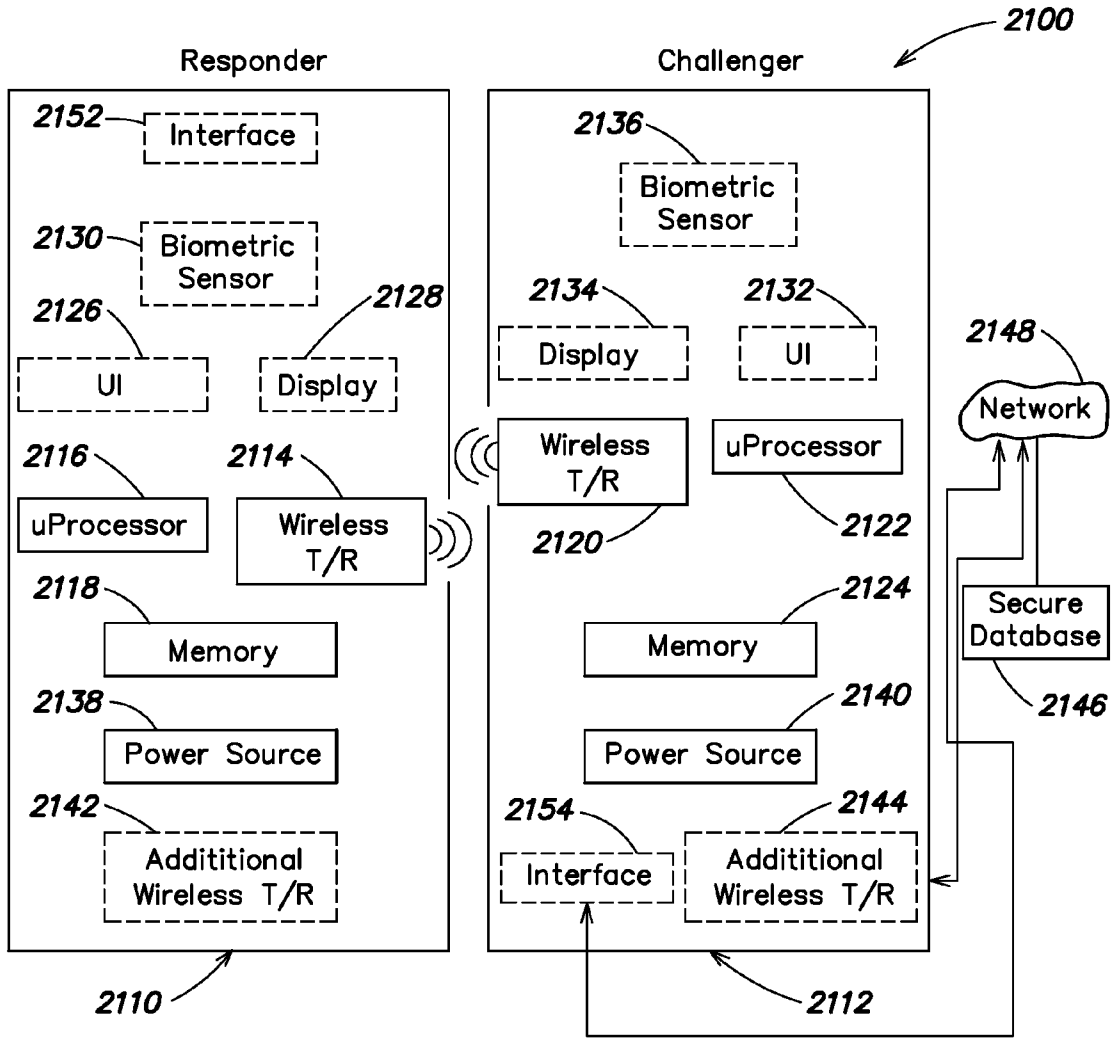

FIG. 21

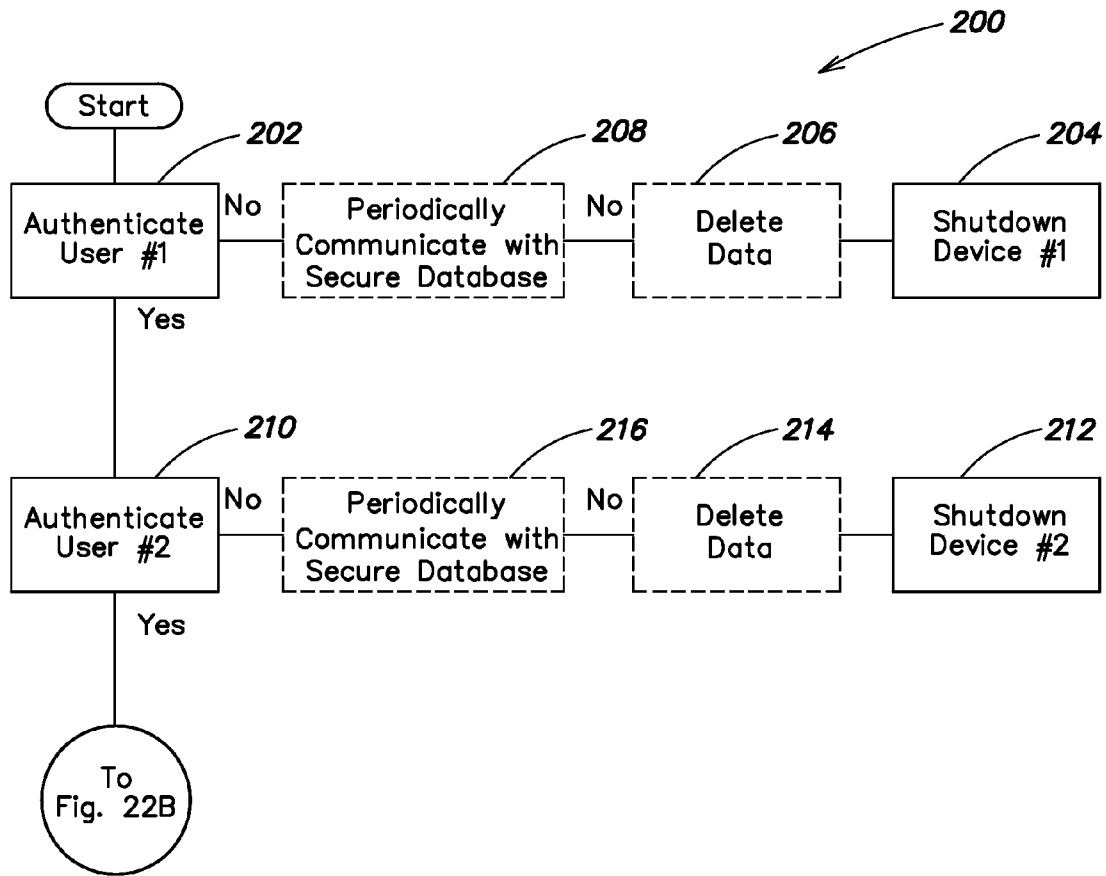

FIG. 22A

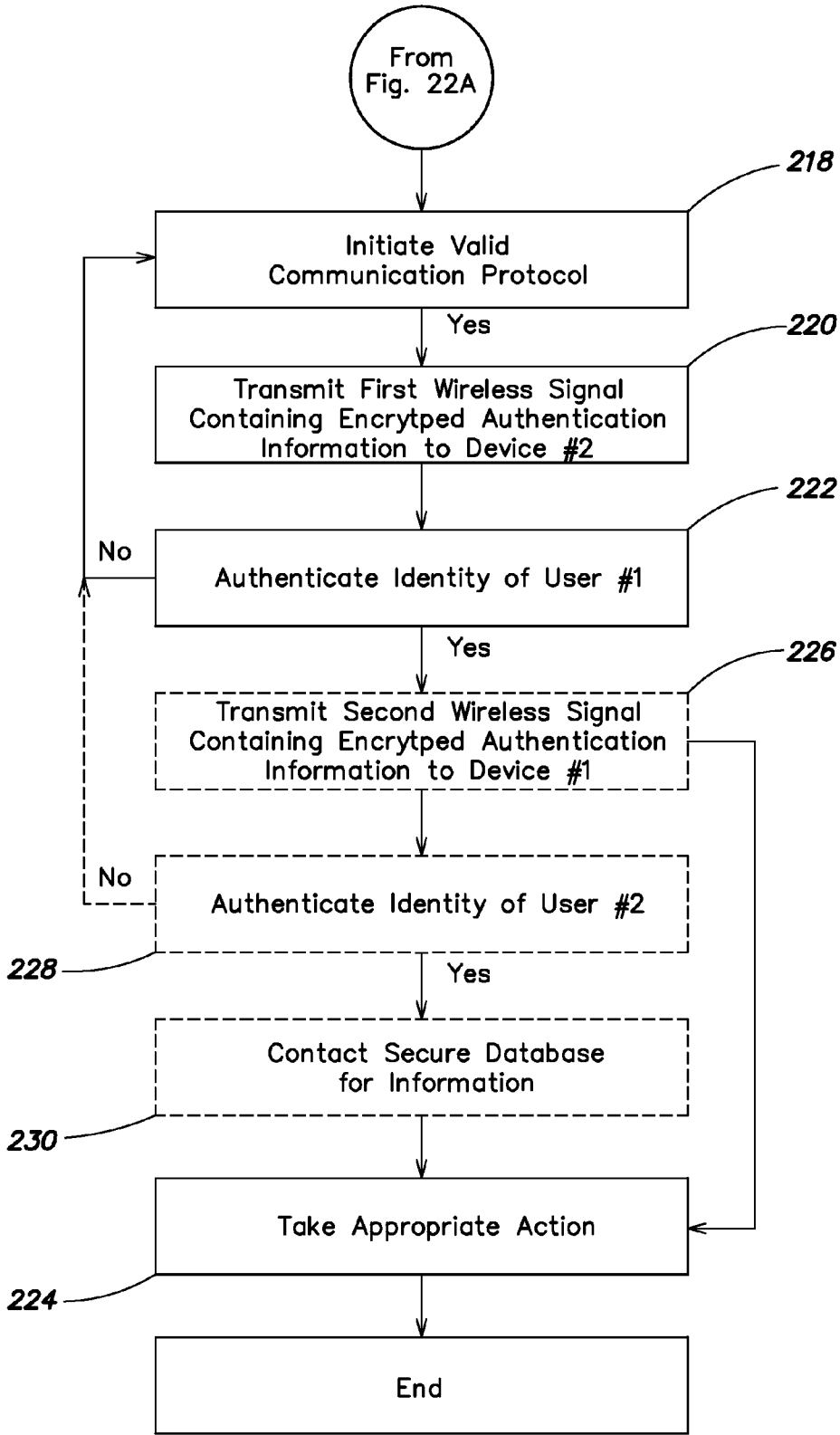

FIG. 22B

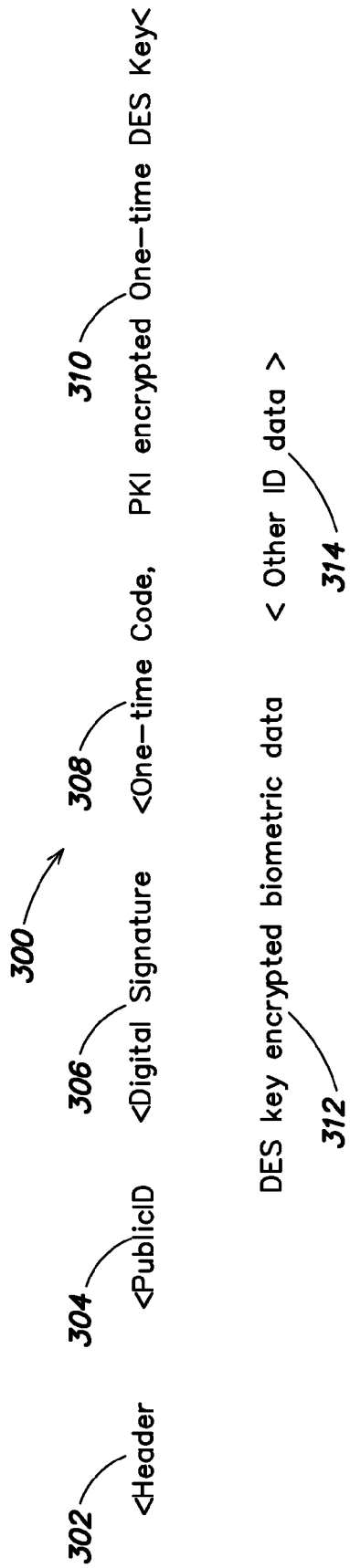

FIG. 23

400 →

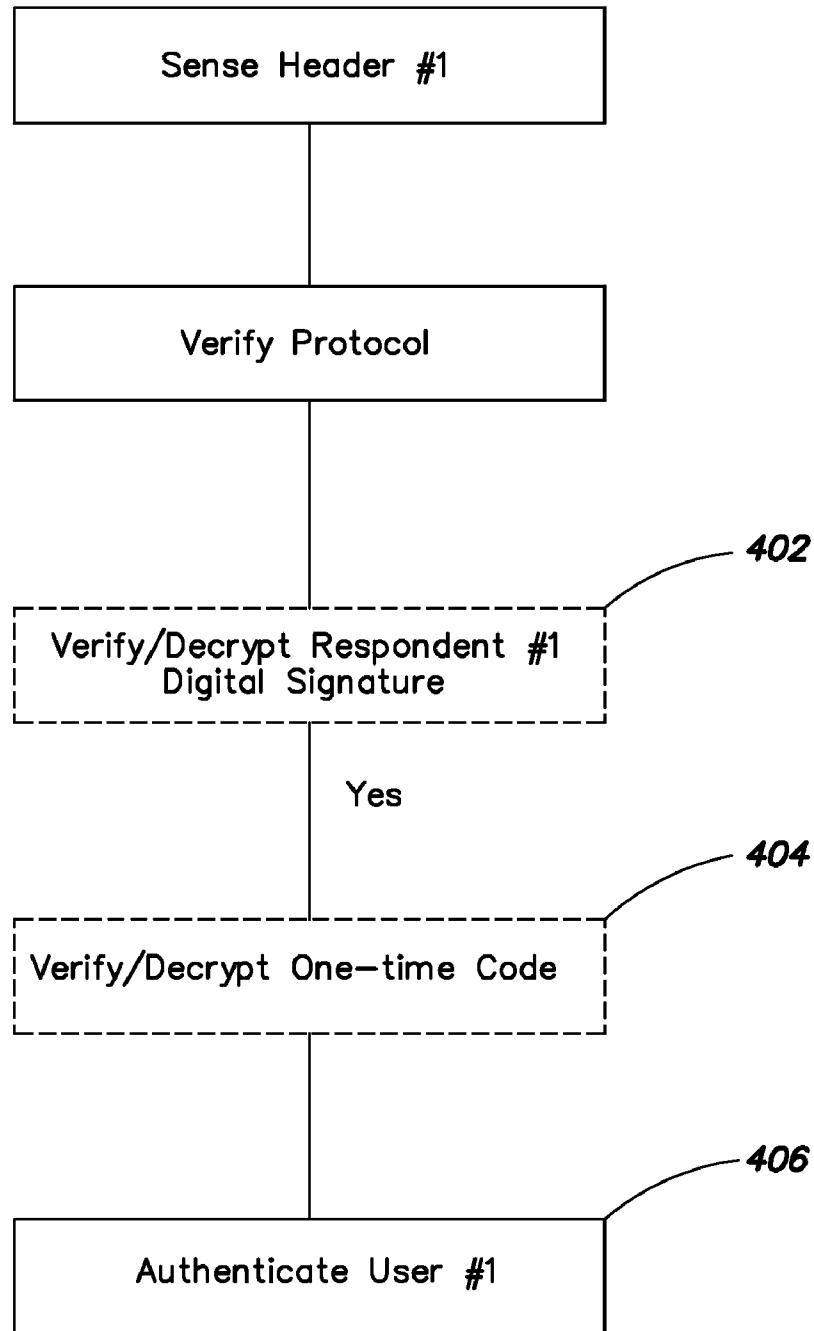

FIG. 24

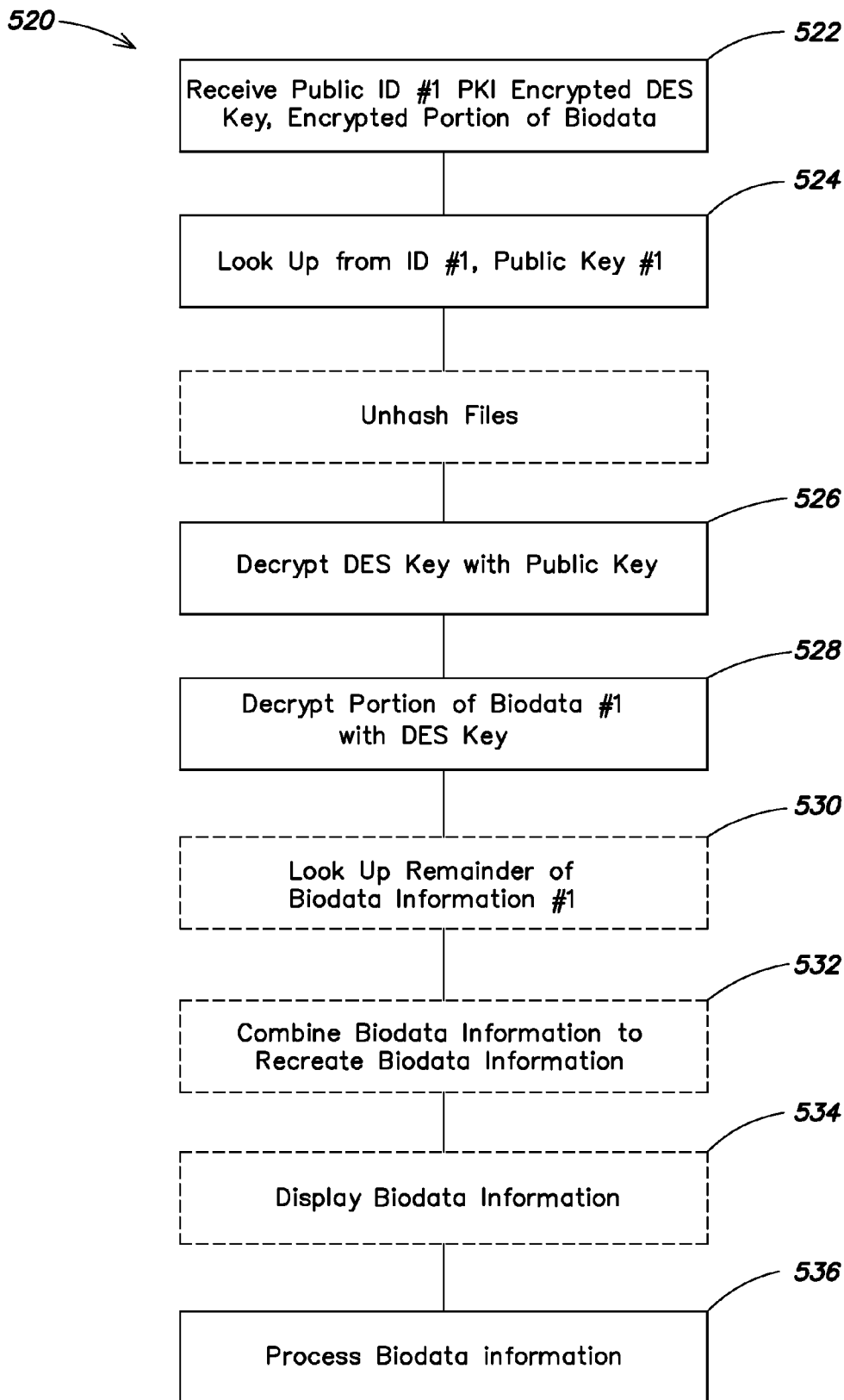

FIG. 25

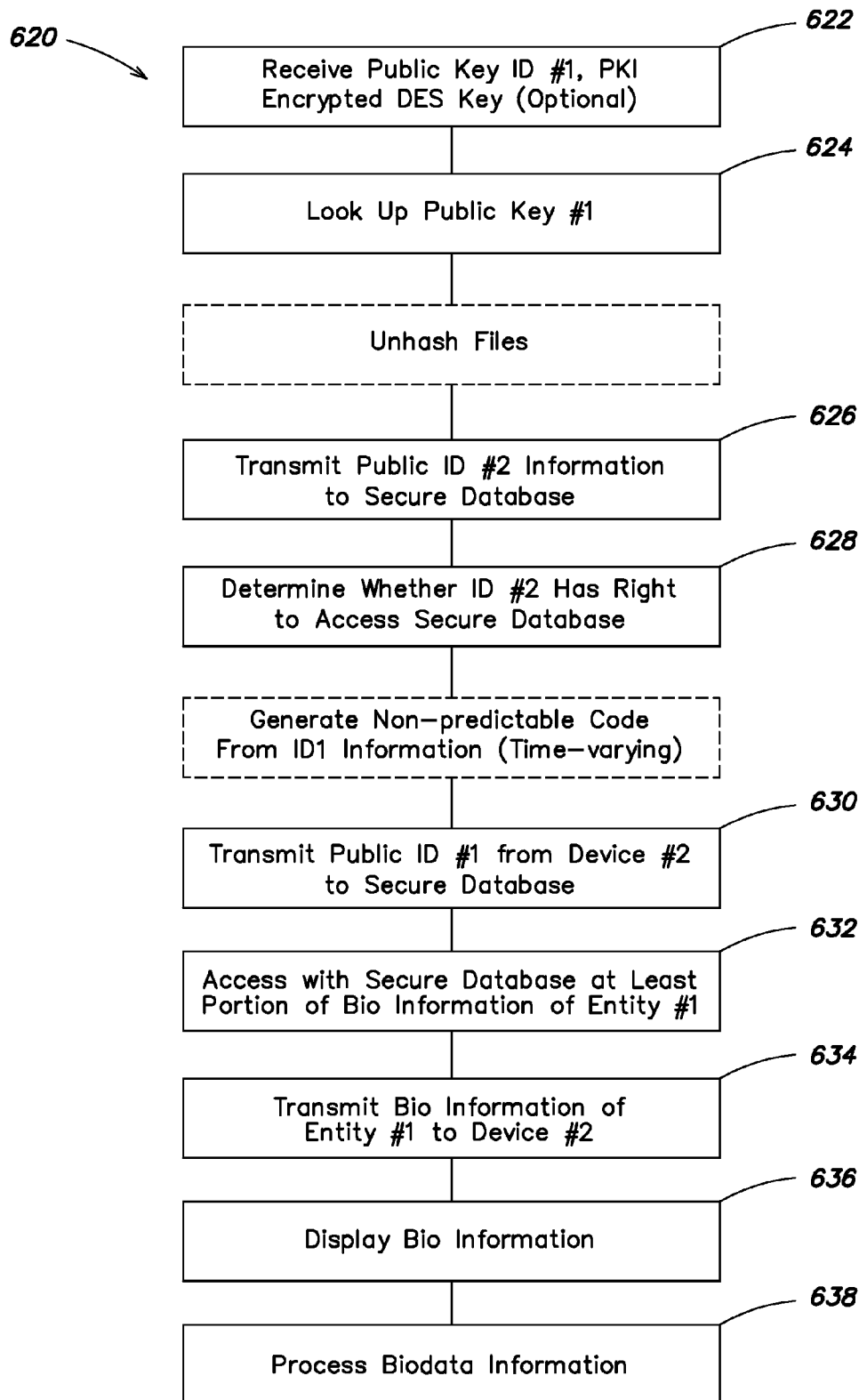

FIG. 26

720 →

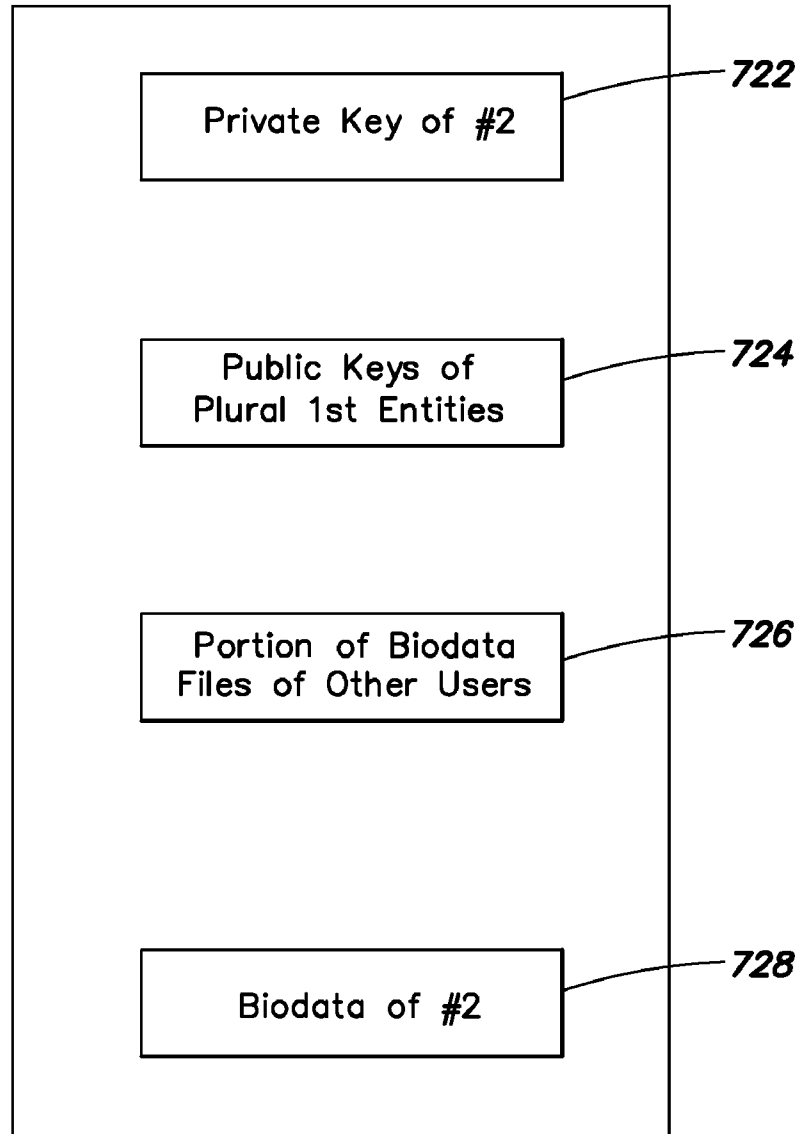

FIG. 27

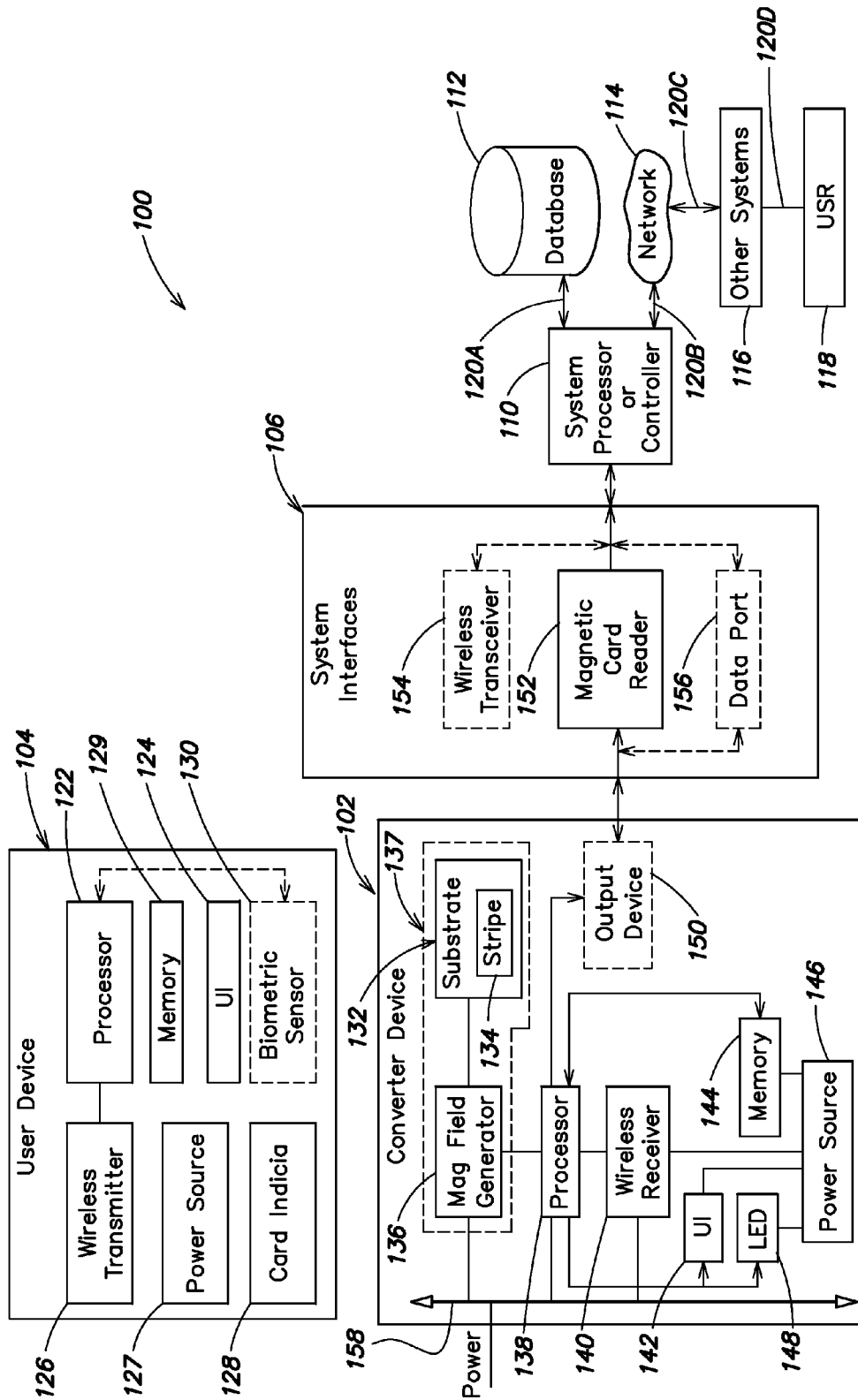

FIG. 28

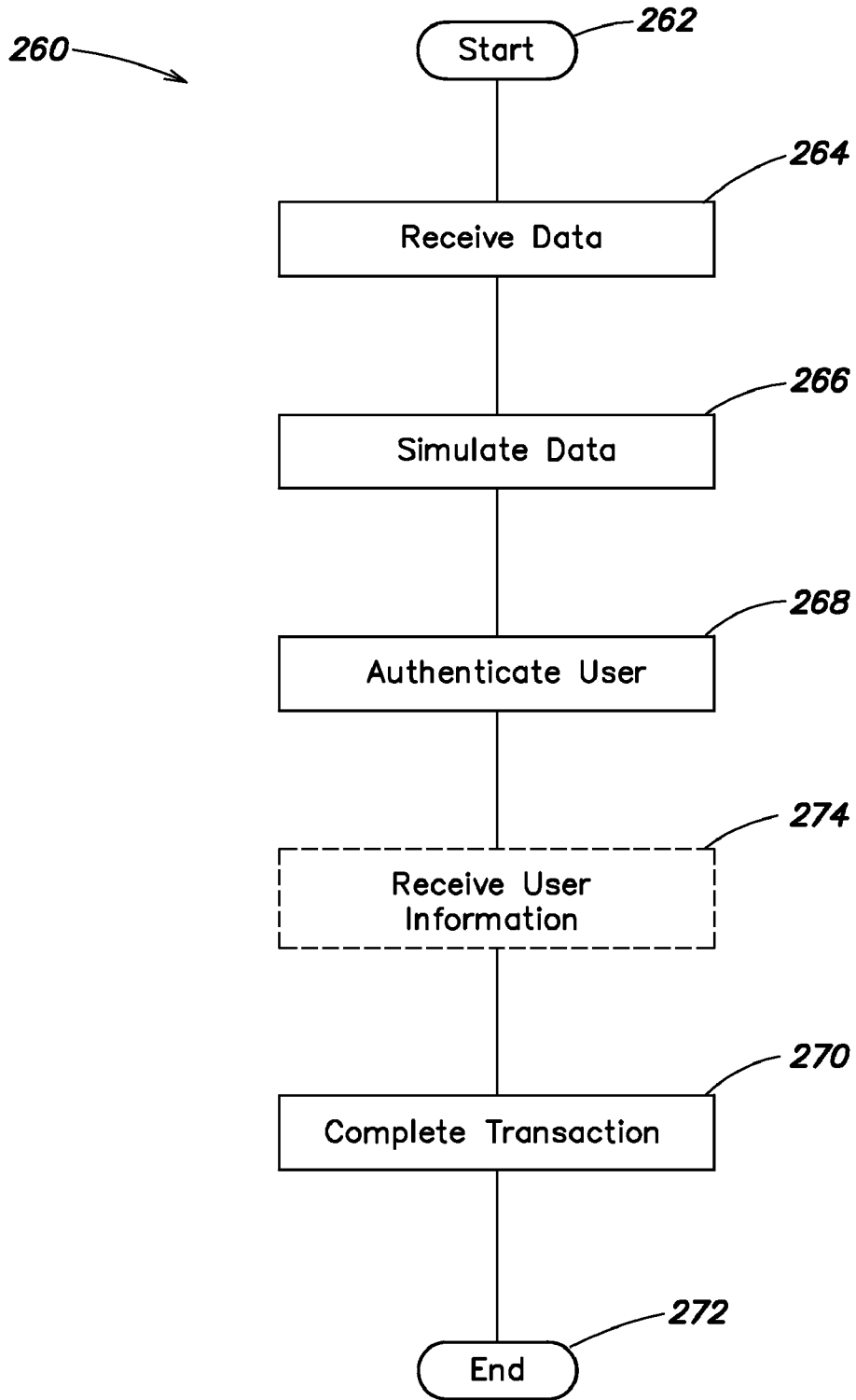

FIG. 29

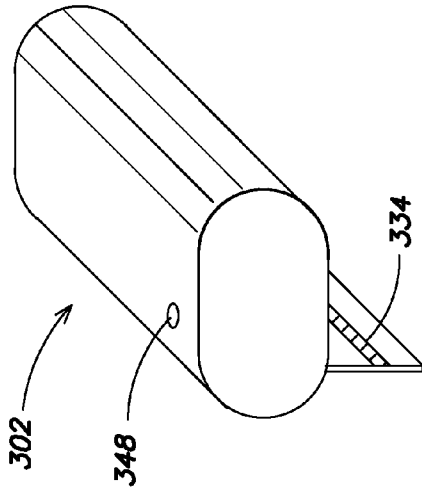

FIG. 30B

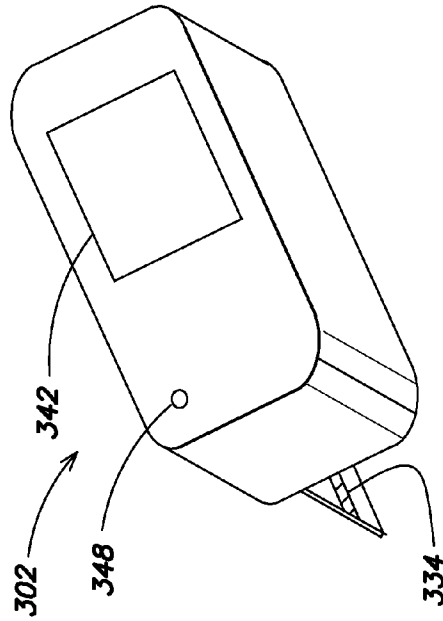

FIG. 30D

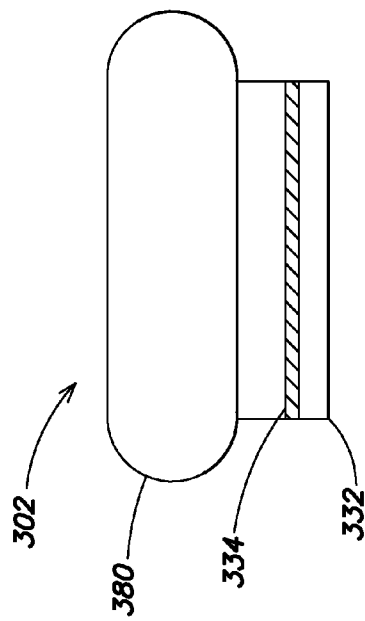

FIG. 30A

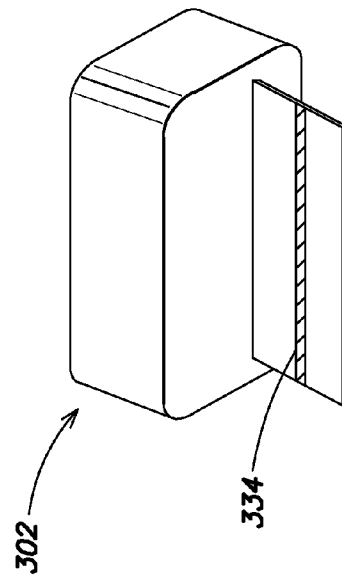

FIG. 30C

UNIVERSAL SECURE REGISTRY

CROSS REFERENCE TO RELATED APPLICATIONS

This application is a continuation under 35 U.S.C. §120 of U.S. patent application Ser. No. 11/677,490 was filed on Feb. 21, 2007, which is hereby incorporated herein by reference in its entirety, and which claims priority to U.S. provisional application Ser. No. 60/775,046 filed Feb. 21, 2006; to U.S. provisional application Ser. No. 60/812,279 filed Jun. 9, 2006; and to U.S. provisional application Ser. No. 60/859,235 filed Nov. 15, 2006. This application also claims priority under 35 U.S.C. §119(e) to each of the following co-pending U.S. provisional patent applications: Ser. No. 60/812,279 filed Jun. 9, 2006; and Ser. No. 60/859,235 filed Nov. 15, 2006 each of which is hereby incorporated herein by reference in its entirety.

BACKGROUND OF INVENTION

1. Field of Invention

Embodiments of the invention generally relate to systems, methods, and apparatus for authenticating identity or verifying the identity of individuals and other entities seeking access to certain privileges and for selectively granting privileges and providing other services in response to such identifications/verifications. In addition, embodiments of the invention relate generally to systems and methods for obtaining information from and/or transmitting information to a user device and, in particular, to systems, methods, and apparatus that provide for contactless information transmission.

2. Discussion of Related Art

Control of access to secure systems presents a problem related to the identification of a person. An individual may be provided access to the secure system after their identity is authorized. Generally, access control to secure computer networks is presently provided by an authentication scheme implemented, at least partly, in software located on a device being employed to access the secure computer network and on a server within the secure computer network. For example, if a corporation chooses to provide access control for their computer network, they may purchase authentication software that includes server-side software installed on a server in their computer system and corresponding client-side software that is installed on the devices that are used by employees to access the system. The devices may include desktop computers, laptop computers, and handheld computers (e.g., PDAs and the like).

In practice, the preceding approach has a number of disadvantages including both the difficulty and cost of maintaining the authentication system and the difficulty and cost of maintaining the security of the authentication system. More specifically, the software resides in the corporation's computers where it may be subject to tampering/unauthorized use by company employees. That is, the information technology team that manages the authentication system has access to the private keys associated with each of the authorized users. As a result, these individuals have an opportunity to compromise the security of the system. Further, any modification and/or upgrade to the authentication system software is likely to require an update to at least the server-side software and may also require an update of the software located on each user/client device. In addition, where the company's computer systems are geographically distributed, software upgrades/updates may be required on a plurality of geographically distributed servers.

There is also a need, especially in this post Sep. 11 environment, for secure and valid identification of an individual before allowing the individual access to highly secure areas. For example, an FBI agent or an air marshal may need to identify themselves to airport security or a gate agent, without compromising security. Typically such identification may comprise the air marshal or FBI agent showing identification indicia to appropriate personnel. However, there are inherent flaws in this process that allow for security to be compromised, including falsification of identification information and failure of the airport security or other personnel to recognize the situation. Of course this process could be automated, for example, by equipping airport personnel or security with access to a database and requiring the FBI agent or air marshal to appropriately identify themselves to the database, for example, by again providing identification which airport personnel can then enter into the database to verify the identity of the person seeking access to a secure area. However, this process also has the inherent flaws in it as described above. In addition, there may be times when airport security or personnel may not be able to communicate with the database to check the identity of the person seeking access, for example, when they are not near a computer terminal with access to a database or are carrying a hand-held device that does not have an appropriate wireless signal to access the database. In addition, there is a need to ensure that if such a hand-held device ends up the wrong hands, that security is not compromised.

Further, both commercial (e.g., banking networks) and non-commercial (e.g., security systems) information systems often rely on magnetic card readers to collect information specific to a user (e.g., a security code, a credit card number, etc.) from a user device (e.g., a transaction card). Credit card purchases made in person provide an example of the most common transaction-type that relies on a user device, the credit or debit card, which is read by a magnetic card reader. User devices that rely on magnetic-stripe based technology magnetically store information (e.g., binary information) in the magnetic stripe. The magnetic stripe reader provides an interface to a larger computerized network that receives the user's information to determine, for example, whether to authorize a transaction, to allow the user access to a secure area, etc.

Recently, such devices have seen technological advances that increase their capabilities and improve their security. For example, such devices may now include embedded processors, integral biometric sensors that sense one or more biometric feature (e.g., a fingerprint) of the user, and magnetic stripe emulators. As one result, such devices may provide greater security by dynamically generating the necessary information, for example, generating the credit card number at the time of a transaction. Improved security can also be provided by such devices because more sophisticated authentication schemes can be implemented with the devices.

In addition, user devices such as transaction cards may now also provide for one or more modes of information transmission other than transmission via a magnetic stripe/card reader combination. For example, user devices that may transmit information optically or via radio frequency ("RF") signal transmission to a compatible system interface are now available. Further, the architecture of a user device that includes a processor is generally compatible with both the improved security features described above and the contactless transmission modes such as optical and RF signal transmission. As a result of the improved security and greater functionality of some current user devices, there is a desire to replace mag-

netic-stripe based user devices with devices that include forms of information transmission other than the reading of a magnetic-stripe.

There is, however, a substantial installed base of interfaces (for example, at points of sale, at automatic teller machines (“ATM”), and the like) that include magnetic card readers which are not equipped to receive information from a user device in any other format other than from a magnetic stripe. As a result of the cost to replace or retrofit the installed base, efforts to more-widely introduce user devices that do not employ magnetic stripe devices have not been developed. Because of the potential to substantially reduce fraud, however, the further implementation of such devices is of great interest to financial institutions among others. RF devices that transmit information wirelessly are expected to become much more prevalent and at some point, the predominant form of information transmission for user authentication based on a hand-held device, for example, credit card, debit card, drivers license, passport, social security card, personal identification, etc. Thus, new and improved methods for transitioning from a purely magnetic based form of communication to a wireless form of communication are desired.

One current approach that is intended to “transform” a smart card for use with a magnetic stripe card reader employs a “bridge” device. The bridge device requires that the smart card be inserted within it. The bridge device includes a slot for receiving the smart card, a key pad whereby the user may enter information (e.g., a PIN number), and a credit card sized extension member. Operation of the bridge device requires that the smart card be inserted within it and that an electrical contact surface of the smart card engage a similar surface within the bridge device before the bridge device (i.e., the extension member) can be used with a magnetic card reader. Thus, the contactless nature of more advanced information transmission systems is lost with the bridge device because it does not support wireless signal transmission.

Accordingly, there is a desire for one or more devices, systems and methods for accomplishing any of the herein mentioned objectives.

SUMMARY OF INVENTION

There is thus a need for an identification system that will enable a person to be accurately identified (“identification” sometimes being used hereinafter to mean either identified or verified) and/or authenticated without compromising security, to gain access to secure systems and/or areas. Likewise, there is a need for an identification system that will enable a person to be identified universally without requiring the person to carry multiple forms of identification.

Accordingly, this invention relates, in one embodiment, to an information system that may be used as a universal identification system and/or used to selectively provide information about a person to authorized users. Transactions to and from a secure database may take place using a public key/private key security system to enable users of the system and the system itself to encrypt transaction information during the transactions. Additionally, the private key/public key security system may be used to allow users to validate their identity. For example, in one embodiment, a smart card such as the Secure ID™ card from RSI Security, Inc. may be provided with the user’s private key and the USR system’s public key to enable the card to encrypt messages being sent to the USR system and to decrypt messages from the USR system 10.

The system or database of the invention may be used to identify the person in many situations, and thus may take the place of multiple conventional forms of identification. Addi-

tionally, the system may enable the user’s identity to be confirmed or verified without providing any identifying information about the person to the entity requiring identification. This can be advantageous where the person suspects that providing identifying information may subject the identifying information to usurpation.

Access to the system may be by smart card, such as a Secure ID™ card, or any other secure access device. The technology enabling the user to present their identity information may be physically embodied as a separate identification device such as a smart ID card, or may be incorporated into another electronic device, such as a cell phone, pager, wrist watch, computer, personal digital assistant such as a Palm Pilot™, key fob, or other commonly available electronic device. The identity of the user possessing the identifying device may be verified at the point of use via any combination of a memorized PIN number or code, biometric identification such as a fingerprint, voice print, signature, iris or facial scan, or DNA analysis, or any other method of identifying the person possessing the device. If desired, the identifying device may also be provided with a picture of the person authorized to use the device to enhance security.

According to one embodiment of the invention, a method of controlling access to a plurality of secure computer networks using a secure registry system located remotely from the secure computer networks is disclosed. The secure registry system includes a database containing selected data of a plurality of users each authorized to access at least one of the plurality of secure computer networks. The method comprises acts of receiving authentication information from an entity at a secure computer network, communicating the authentication information to the secure registry system, and validating the authentication information at the secure registry system. The method also includes receiving from the secure registry system an indication of whether the entity is authorized to access the secure computer network, granting the entity access to the secure computer network when the authentication information of the entity corresponds to one of the plurality of users, and denying the entity access to the secure computer network when the authentication information of the user does not correspond to one of the plurality of users.

Another embodiment of the invention comprises a method of controlling access to a secure computer network using a secure registry system. The secure registry system includes a database containing selected data of a plurality of users authorized to access the secure computer network and selected data identifying the secure computer network. The method comprises receiving an access request including authentication information and a computer network ID from an entity, determining whether the authentication information is valid for any of the plurality of users, accessing data when the authentication information of the entity is valid for one of the plurality of users to determine whether the entity is authorized to access the computer network identified by the computer network ID, and allowing the entity to access the secure computer network when the authentication information of the entity is valid for one of the plurality of users authorized to access the computer network identified by the computer network ID.

Another embodiment of the invention comprises a method of authenticating an identity of a first entity. The method comprises the acts of wirelessly transmitting from a first device, first encrypted authentication information of the first entity, receiving with a second device the wirelessly transmitted first encrypted authentication information, decrypting with the second device, the first wirelessly encrypted authen-

5

tication information to provide the first authentication information of the first entity to the second device; and authenticating the identity of the first entity based upon the first authentication information; and acting based on the assessed identity of the first entity.

Another embodiment of the invention comprises a system for authenticating an identity of a first entity, comprising a first wireless device comprising a first wireless transmitter and receiver configured to transmit a first wireless signal including first encrypted authentication information, a first processor configured to compare stored biometric data with detected biometric data of the first entity and configured to enable or disable use of the first device based on a result of the comparison, and configured to encrypt first authentication information with a first private key of the first entity into the first encrypted authentication information, a first biometric detector for detecting biometric data of the first entity, and a first memory for storing biometric data of the first entity, a private key of the first entity authorized to use the first device, and the first authentication information.

According to some embodiments, the system further comprises a second wireless device comprising a second wireless transmitter and receiver configured to receive the first wireless signal and to process the first wireless signal, a second processor configured to compare detected biometric data of a second entity with stored biometric data and configured to enable or disable use of the second device based upon a result of the comparison, and configured to decrypt the first authentication information received in the first wireless signal, a biometric detector for detecting biometric data of a second entity, and a second memory storing biometric data of the second entity and a plurality of public keys of a plurality of first entities.

Another embodiment of the invention provides a first wireless device comprising a processor configured to enable operation of the first wireless device if it receives an enablement signal validating first biometric information of a first entity and configured to generate a non-predictable signal from the biometric information, a first wireless transmitter and receiver configured to transmit a first wireless signal including first encrypted biometric information of the first entity and to receive the enablement signal, and a first biometric detector for detecting the first biometric information of the first entity.

In one aspect of the invention, a device converts a wireless transaction device to a magnetic-stripe emulator device. In one embodiment, the device includes a wireless signal receiver that is configured to receive a wireless signal and provide information from the wireless signal. In addition, the device may include a magnetic-stripe emulator which is communicatively coupled to the wireless signal receiver and adapted to provide a time-varying signal which emulates data provided by a magnetic-stripe card to a magnetic card reader in response to receiving the information from the wireless signal. In one embodiment, the device includes a processor communicatively coupled to the wireless signal receiver and to the magnetic-stripe emulator. The device may also include an LED. In a version of this embodiment, the processor is configured to control the LED to indicate that the device is properly aligned with the magnetic card reader. In another embodiment, the device includes an output device that can provide information to a network or to a network device. In a version of this embodiment, the output device is a wireless transmitter device.

Further embodiments of the invention may include additional features, for example, in one embodiment the output device is a data port to which the device can provide data to a

6

network or to a network device. In a version of this embodiment, the data port is also configured to receive data from the network or the network's device. In a further embodiment, the device is configured to communicate with the magnetic card reader via the data port.

In a further embodiment, the wireless receiver and/or processors configure, decrypt and encrypt the wireless signal. In a further embodiment, the processor is configured to determine whether a user is authorized to provide the information contained within the wireless signal from data within the wireless signal. In a version of this embodiment, the data contained within the wireless signal includes user ID information. In yet another embodiment, the data contained within the wireless signal includes biometric information of the user.

According to another aspect, the invention provides a system for validating an identity of a user to enable or prevent an occurrence of an event. In one embodiment, the system includes a first device including a wireless transmitter which is configured to transmit validation information, a second device including a wireless receiver, where the second device is configured to receive the validation information and further transmit the validation information; and a secure system in communication with the second device. According to one embodiment, the secure system includes a database. In a further embodiment, the secure system is configured to receive the validation information transmitted from the second device, and to transmit additional information to the second device following a receipt of the validation information to assist the second device in either enabling or preventing the occurrence of the event. In various embodiments, the event that is enabled or prevented may be a transaction (e.g., a financial transaction), access control (e.g., physical or electronic access) or other action that is either enabled or prevented.

According to a further aspect, the invention provides a method employing a system to validate an identity of a user to enable or prevent an occurrence of an event. In one embodiment, the system includes a first device, a second device and a secure system including a database. According to one embodiment, the method includes acts of receiving at the second device validation information wirelessly transmitted from the first device, communicating the validation information from the second device to the secure system, and receiving at the second device additional information from the secure system. In a further embodiment, the additional information assists the second device in either enabling or preventing the occurrence of the event. In various embodiments, the event that is enabled or prevented may be a transaction (e.g., a financial transaction), access control (e.g., physical or electronic access) or other action that is either enabled or prevented.

BRIEF DESCRIPTION OF DRAWINGS

This invention is pointed out with particularity in the appended claims. The above and further advantages of this invention may be better understood by referring to the following description when taken in conjunction with the accompanying drawings. The accompanying drawings are not intended to be drawn to scale. In the drawings, each identical or nearly identical component that is illustrated in various figures is represented by a like numeral. For purposes of clarity, not every component may be labeled in every drawing. In the drawings:

FIG. 1 is a functional block diagram of a computer system configured to implement the universal secure registry (“USR”), including a USR database, according to one embodiment of the invention;

FIG. 2 is a functional block diagram of a first embodiment of a networked environment including the computer system of FIG. 1;

FIG. 3 is a functional block diagram of an entry of a database forming the USR database of FIG. 1;

FIG. 4 is a functional block diagram of a second embodiment of a networked environment including the computer system of FIG. 1;

FIG. 5 is a flow chart illustrating steps in a process of inputting data into the USR database;

FIG. 6 is a flow chart illustrating steps in a process of retrieving data from the USR database;

FIG. 7 is a flow chart illustrating a first protocol for purchasing goods from a merchant via the USR database without transmitting credit card information to the merchant;

FIG. 8 is a flow chart illustrating a second protocol for purchasing goods from a merchant via the USR database without transmitting credit card information to the merchant;

FIG. 9 is a flow chart illustrating a protocol for purchasing goods from a merchant via the USR database by validating the user’s check;

FIG. 10 is a flow chart illustrating a protocol for purchasing goods from an on-line merchant via the USR database without transmitting credit card information to the on-line merchant, and enabling the on-line merchant to ship the goods to a virtual address;

FIG. 11 is a flow chart illustrating a protocol for shipping goods to a virtual address via the USR database;

FIG. 12 is a flow chart illustrating a protocol for telephoning a virtual phone number via the USR database;

FIG. 13 is a flow chart illustrating a protocol for identifying a person via the USR database;

FIG. 14 is a flow chart illustrating a protocol for identifying a person to a policeman via the USR database;

FIG. 15 is a flow chart illustrating a protocol for providing information to an authorized recipient of the information via the USR database;

FIG. 16 is a flow chart illustrating a protocol for providing application information to an authorized recipient of the information via the USR database;

FIG. 17 is a functional block diagram of an embodiment configured to use information in the USR system to activate or keep active property secured through the USR system; and

FIG. 18A is a functional block diagram of an embodiment configured to use the USR system to control access to a secure computer network;

FIG. 18B is a functional block diagram of another embodiment configured to use the USR system to control access to a secure computer network;

FIG. 19 is a flow diagram of a process for controlling access to a secure computer network with the USR system in accordance with an embodiment of the invention;

FIG. 20 is a flow diagram of a process for controlling access to a secure computer network with the USR system in accordance with another embodiment of the invention;

FIG. 21 illustrates an embodiment of a system for validating the identity of an individual;

FIGS. 22A and 22B illustrate one embodiment of a process for validating the identity of an individual;

FIG. 23 illustrates one embodiment of various fields included within a first wireless signal and a second wireless signal as transmitted by the system of FIG. 21;

FIG. 24 illustrates one embodiment of a process for verifying or authenticating the identity of a first user of a first wireless transmission device;

FIG. 25 illustrates another embodiment of a process for authenticating the identity of a first user of a wireless transmission device;

FIG. 26 illustrates still another embodiment of a process for authenticating the identity of a first user of a wireless transmission device; and

FIG. 27 illustrates one embodiment of a data structure that can be used by any wireless device of the system of FIG. 21;

FIG. 28 illustrates a system in accordance with one embodiment of the invention;

FIG. 29 illustrates a process in accordance with an embodiment of the invention; and

FIGS. 30A-30D illustrate a converter device in accordance with one embodiment of the invention.

DETAILED DESCRIPTION

This invention is not limited in its application to the details of construction and the arrangement of components set forth in the following description or illustrated in the drawings. The invention is capable of other embodiments and of being practiced or of being carried out in various ways. Also, the phraseology and terminology used herein is for the purpose of description and should not be regarded as limiting. The use of “including,” “comprising,” or “having,” “containing”, “involving”, and variations thereof herein, is meant to encompass the items listed thereafter and equivalents thereof as well as additional items.

In one embodiment, an information system is formed as a computer program running on a computer or group of computers configured to provide a universal secure registry (USR) system. The computer, in this instance, may be configured to run autonomously (without the intervention of a human operator), or may require intervention or approval for all, a selected subset, or particular classes of transactions. The invention is not limited to the disclosed embodiments, and may take on many different forms depending on the particular requirements of the information system, the type of information being exchanged, and the type of computer equipment employed. An information system according to this invention, may optionally, but need not necessarily, perform functions additional to those described herein, and the invention is not limited to a computer system performing solely the described functions.

In the embodiment shown in FIG. 1, a computer system 10 for implementing a USR system according to the invention includes at least one main unit 12 connected to a wide area network, such as the Internet, via a communications port 14. The main unit 12 may include one or more processors (CPU 16) running USR software 18 configured to implement the USR system functionality discussed in greater detail below. The CPU 16 may be connected to a memory system including one or more memory devices, such as a random access memory system RAM 20, a read only memory system ROM 22, and one or more databases 24. In the illustrated embodiment, the database 24 contains a universal secure registry database. The invention is not limited to this particular manner of storing the USR database. Rather, the USR database may be included in any aspect of the memory system, such as in RAM 20, ROM 22 or disc, and may also be separately stored on one or more dedicated data servers.

The computer system may be a general purpose computer system which is programmable using a computer programming language, such as C, C++, Java, or other language, such

as a scripting language or even assembly language. The computer system may also be specially programmed, special purpose hardware, an application specific integrated circuit (ASIC) or a hybrid system including both special purpose components and programmed general purpose components.

In a general purpose computer system, the processor is typically a commercially available microprocessor, such as Pentium series processor available from Intel, or other similar commercially available device. Such a microprocessor executes a program called an operating system, such as UNIX, Linux, Windows NT, Windows 95, 98, or 2000, or any other commercially available operating system, which controls the execution of other computer programs and provides scheduling, debugging, input/output control, accounting, compilation, storage assignment, data management, memory management, communication control and related services, and many other functions. The processor and operating system defines a computer platform for which application programs in high-level programming languages are written.

The database **24** may be any kind of database, including a relational database, object-oriented database, unstructured database, or other database. Example relational databases include Oracle 81 from Oracle Corporation of Redwood City, Calif.; Informix Dynamic Server from Informix Software, Inc. of Menlo Park, Calif.; DB2 from International Business Machines of Armonk, N.Y.; and Access from Microsoft Corporation of Redmond, Wash. An example object-oriented database is ObjectStore from Object Design of Burlington, Mass. An example of an unstructured database is Notes from the Lotus Corporation, of Cambridge, Mass. A database also may be constructed using a flat file system, for example by using files with character-delimited fields, such as in early versions of dBASE, now known as Visual dBASE from Inprise Corp. of Scotts Valley, Calif., formerly Borland International Corp.

The main unit **12** may optionally include or be connected to an user interface **26** containing, for example, one or more input and output devices to enable an operator to interface with the USR system **10**. Illustrative input devices include a keyboard, keypad, track ball, mouse, pen and tablet, communication device, and data input devices such as voice and other audio and video capture devices. Illustrative output devices include cathode ray tube (CRT) displays, liquid crystal displays (LCD) and other video output devices, printers, communication devices such as modems, storage devices such as a disk or tape, and audio or video output devices. Optionally, the user interface **26** may be omitted, in which case the operator may communicate with the USR system **10** in a networked fashion via the communication port **14**. It should be understood that the invention is not limited to any particular manner of interfacing an operator with the USR system.

It also should be understood that the invention is not limited to a particular computer platform, particular processor, or particular high-level programming language. Additionally, the computer system may be a multiprocessor computer system or may include multiple computers connected over a computer network. It further should be understood that each module or step shown in the accompanying figures and the substeps or subparts shown in the remaining figures may correspond to separate modules of a computer program, or may be separate computer programs. Such modules may be operable on separate computers. The data produced by these components may be stored in a memory system or transmitted between computer systems.

Such a system may be implemented in software, hardware, or firmware, or any combination thereof. The various ele-

ments of the information system disclosed herein, either individually or in combination, may be implemented as a computer program product, such as USR software **18**, tangibly embodied in a machine-readable storage device for execution by the computer processor **16**. Various steps of the process may be performed by the computer processor **16** executing the program **18** tangibly embodied on a computer-readable medium to perform functions by operating on input and generating output. Computer programming languages suitable for implementing such a system include procedural programming languages, object-oriented programming languages, and combinations of the two.

As shown in FIG. 2, the computer system **10** may be connected to a plurality of interface centers **27** over a wide area network **28**. The wide area network **28** may be formed from a plurality of dedicated connections between the interface centers **27** and the computer system **10**, or may take place, in whole or in part, over a public network such as the Internet. Communication between the interface centers **27** and the computer system **10** may take place according to any protocol, such as TCP/IP, ftp, OFX, or XML, and may include any desired level of interaction between the interface centers **27** and the computer system **10**. To enhance security, especially where communication takes place over a publicly accessible network such as the Internet, communications facilitating or relating to transmission of data from/to the USR database **24** or the computer system **10** may be encrypted using an encryption algorithm, such as PGP, DES, or other conventional symmetric or asymmetric encryption algorithm.

In one embodiment, the USR system **10** or USR database **24** may be able to authenticate its identity to a user or other entity accessing the system by providing an appropriate code which may be displayed on the user's smart card, for example a SecurID™ card or its equivalent, or other code generator, for example a single use code generator, being employed by the user. A comparison by the user or the code generator between the provided number and an expected number can validate, to the user (or other entity) or the code generator, that communication is with the database and not an imposter. In another embodiment, a challenge-response protocol is employed to authenticate the identity of the USR system and/or the user to the other.

The database **24** shown in FIG. 1 has a USR database containing entries related to persons **1-n**. The data in the USR database may also be segregated, as shown in FIG. 4, according to data type to enable individual computer modules to handle discrete applications on discrete data types. Segregating the data, as illustrated in FIG. 4, may make access to the database more robust by enabling portions of the data in the USR database **24** to be accessible even when it is necessary to perform maintenance on a portion of the database. However, storing the data in the USR database **24** according to the scheme illustrated in FIG. 1 may make it easier for a user of the database to make changes to multiple types of data simultaneously or in a single session. There are advantages and disadvantages to each data structure, and the invention is not limited to a particular manner of organizing the data within the database **24**, data structures other than the two shown also being possible.

As shown in FIG. 3, each entry **30** in the database **24** may contain multiple types of information. For example, in the embodiment shown in FIG. 3, the entry contains validation information **32**, access information **34**, publicly available information **36**, address information **38**, credit card and other financial information **40**, medical information **42**, job application information **44**, and tax information **46**. The invention

is not limited to a USR containing entries with all of this information or only this particular information, as any information on a person or other entity such as a company, institution, etc. may be stored in USR database **24**.

If the database information is split between multiple databases, each database will typically include at least the validation and access information to enable the USR software to correlate a validation attempt with a verified validation, and to enable the USR software to determine access privileges to the requested data. Alternatively, databases may be linked to permit information not in a main USR database to be retrieved, with validation/identification for all databases accessed being done at the USR system.

In FIG. **3**, the validation information is information about the user of the database to whom the data pertains and is to be used by the USR software **18** to validate that the person attempting to access the information is the person to whom the data pertains or is otherwise authorized to receive it. The validation information may be any type of information that will reliably authenticate the identity of the individual. For example, in some embodiments, the information may include any of a secret known by the user (e.g., a pin, a phrase, a password, etc.), a token possessed by the user that is difficult to counterfeit (e.g., a secure discrete microchip), and/or a measurement such as a biometric (e.g., a voiceprint, a fingerprint, DNA, a retinal image, a photograph, etc.).

The user's identifying information may be manually entered or scanned at the interface center. However, a variety of types of communication may be employed to communicate the user's identifying information from the identification card or token to the computer system. For example, near field signal may be employed to communicate information between the identification card or token and the computer system **10**. According to one embodiment, the user's identifying information is included in (or entered via) the user's cell phone where it is then communicated to the computer system **10**. In one embodiment, the cell phone is also configured to receive information from the computer system **10** at the interface center **27**.

In one embodiment, the user of the database will carry a SecurID™ card available from RSA Security, formerly Security Dynamics Technologies, Inc., of Cambridge, Mass. Use of this card enables secure access to the USR database without requiring the user to transmit any personal information. Specifically, to access the USR database, the card retrieves a secret user code and/or time varying value from memory and obtains from the user a secret personal identification code. The card mathematically combines these three numbers using a predetermined algorithm to generate a one-time nonpredictable code which is transmitted to the computer system **10**. The computer system, specifically USR software **18**, utilizes the received one-time nonpredictable code to determine if the user is authorized access to the USR database and grants access to the USR database if the user is determined to be authorized. The verification information **32** in the database entry in the embodiment of the invention illustrated in FIG. **3** contains information to enable the USR software **18** to validate the user using such a card in this manner.

Alternative types of identification cards or tokens may likewise be used. For example, other smart cards may be used which generate non-predictable single use codes, which may or may not be time varying, or other access code generators may be used. An algorithm generating such non-predictable codes may also be programmed onto a processor on a smart card or other computing device, such as a cell phone, pager, ID badge, wrist watch, computer, personal digital assistant, key fob, or other commonly available electronic device. For

convenience, the term "electronic ID device" will be used generically to refer to any type of electronic device that may be used to obtain access to the USR database.

Likewise, various types of biometric information may be stored in the verification area of the database entry to enable the identity of the user possessing the identifying device to be verified at the point of use. Examples of the type of biometric information that may be used in this situation includes a personal identification number (PIN), fingerprint, voice print, signature, iris or facial scan, or DNA analysis. If desired, the verifying section of the database may contain a picture to be transmitted back to the person seeking to validate the device to ensure the person using the device is the correct person. Optionally, the identifying device itself may also be provided with a picture of the person authorized to use the card to provide a facial confirmation of the person's right to use the card.

Further, a challenge-response protocol may be employed in combination with or as an alternative to the preceding to validate the person attempting to access the information. Various embodiments may employ a challenge-response protocol with or without an identification card.

In FIG. **3**, the Access information **34** is provided to enable different levels of security to attach to different types of information stored in the entry **30** in the USR database **14**. For example, the person may desire that their address information be made available only to certain classes of people, for example colleagues, friends, family, Federal Express, U.P.S., and the U.S. mail service. The names or universal identifiers for those selected individuals, companies, organizations and/or agencies may be entered into appropriate fields in the Access information to specify to the USR software **18** those individuals to whom the address information may be released. Likewise, access fields may be specified for the other types of information. For example, the individual may specify that only particular individuals and/or companies have access to the credit card and other financial information **40**, medical information **42**, job application information **44** and tax information **46**. Additionally, the individual may specify that no one have access to that information unless the individual participates in the transaction (see FIG. **6**).

As shown in FIG. **1**, the USR software **18** contains algorithms for execution by the CPU **16** that enables the CPU **16** to perform the methods and functions of the USR software described below in connection with FIGS. **5-16**. The USR software **18**, in this embodiment, performs all functions associated with validating an electronic ID card. If desired, a separate validation software module may be provided to validate electronic ID devices outside of a firewall segregating the validation information from other user information.

This algorithm comprising the USR software **18** may be used to implement, in one exemplary embodiment, a USR system configured to enable selected information to be disseminated to selected individuals in a secure and dynamic fashion. This information may be used for numerous purposes, several of which are set forth below and discussed in greater detail in connection with FIGS. **5-16**.

For example, the USR system may be used to identify the person, enable the person to be contacted by telephone or mail anonymously, enable the person to be contacted by telephone or by mail without revealing the person's telephone number or present location, enable the person to purchase items over the Internet or in a store without revealing to the merchant any personal identification information or credit card information, enable the person to complete a job application without completing a job application form, enable the police to discern the person's identity and any outstanding warrants on the

individual, and numerous other uses. The invention is not limited to these several enumerated uses, but rather extends to any use of the USR database. The methods of using the USR database 24 will now be discussed in connection with FIGS. 5-16.

FIG. 5 illustrates a method of training the USR database 24. As shown in FIG. 5, the USR software 18 first validates the person's identification (500). The initial validation of the person's identification (500) may take place at the point of sale of an electronic ID device (for example, a smart card). This may be done in any conventional manner, such as by requiring the person to show a government issued identification card, passport, birth certificate, etc. Once the person's electronic ID device has been issued and initially validated, the validation process proceeds as discussed above.

After the validation process (500), the USR software 18 determines if the person has rights to enter data into the system (502). This step enables the system to charge persons for maintaining information in the USR database 24. For example, the USR software 18 may poll a database of current accounts or a database of accounts that are currently in default to determine if the person has paid the access fee to enter data into the database. A similar account status inquiry process may be performed by the USR software 18 in connection with each of the other methods set forth in FIGS. 6-16. If the person is not authorized to enter data into the USR database 24, the person is notified of the status of their account and the process returns (512) to wait for further input from another person. Alternatively, a person may be permitted to enter some classes of data into the system and update such classes of data at no charge, with a fee possibly being required for other classes of data, for example medical records. This would facilitate a more robust database.

If the person is authorized, the USR software 18 then enables the person to enter basic personal data into the USR database 24 (504). Optionally, personal data may be one class of data the USR software 18 allows the person to enter into the USR database 18 regardless of account status, i.e., for free.

The USR software 18 will then check to see if the person has additional rights to enter additional data (506), such as data to be entered into one of the other categories of data in FIG. 3. Optionally, this step of checking the person's rights to enter data (506) may be combined with the initial check (502). If the person does not have rights to enter any further data, the USR software 18 notifies the user and returns (512).

If the USR software 18 determines that the person has the right to enter additional data into the USR database 24, the person is prompted through the use of appropriate prompts, provided with forms, and otherwise enabled to enter advanced personal data into the USR database 24 (508). For each type of data entered, the person is asked to specify the type of access restrictions and/or whom should be allowed to access the advanced personal data (510). When the person has completed entering data into the database, the process returns (512) and commits the data to the database.

In the situation where only one person has access to enter and/or modify data for a given person in the database, there should be no conflict with committing data to the database. If, however, multiple people have access to a given account to modify data, the database may perform an integrity check to ensure the absence of conflict in the data before committing the new data to the database.

Enabling access to the information in the database will be explained in greater detail in connection with FIG. 6. As shown in FIG. 6, the database will generally allow anyone to access basic personal data on anyone without performing any authorization check (600).

If information beyond that specified in the basic personal information area is requested, the USR software 18 queries whether the requester has the right to access the type of requested data (602). The process of determining the requestor's rights (602) typically involves validating the requestor's identity and correlating the identity, the requested information and the access information 34 provided by the person to the USR database during the training process described above with respect to FIG. 5.

If the USR software 18 determines that the requester has rights to access the type of requested data (604), the USR software 18 instructs the USR database 24 to enable access to the type of requested data (606). The actual step of enabling access to the type of requested data may involve multiple steps of formulating a database query, querying the USR database 24, retrieving the results, assembling the results into a user friendly or user readable format, and transmitting the information to the user.

If the USR software 18 determines that the requester does not have the appropriate rights to access the type of requested data (604), the USR software 18 checks to see if the person is participating in the transaction (608). Checking to see if the person is participating in the transaction enables the user to authorize access to the requested data in real time. For example, a person may wish to participate in a transaction to give a potential employer one-time access to job application information 44 (see FIG. 3). If the person is not participating in the transaction, the USR software 18 determines that the requester is not authorized to have access to the requested data, notifies the requestor of this determination, and ends (610).

If the person is participating in the transaction (608), however, the USR software 18 validates the person's identity (612) and enables the person to change access rights to the data (614). If the USR software 18 is not able to validate the person's identity, the USR software 18 refuses to allow the person to update the database, notifies the person and/or requestor of this determination, and returns (610).

It is also possible that a person may be required to grant access to certain data, for example financial data such as account numbers, under duress. The system may provide the person with the ability to safely signal this when accessing the system by using a selected access code or by making a known modification to the access code provided by the electronic ID device. On receiving such code, the system would take appropriate steps to protect the person, including for example alerting the police, tracking the person's location to the extent possible, providing traceable data, and the like.

Once the person has had the opportunity to change access rights to the data (614), the USR software 18 again checks to see if the requestor has rights to access the type of requested data (616). Although step 616 may seem redundant, given the fact that the person is participating in the transaction and has just previously changed access rights to the database to enable the requestor to have access to the data, step 616 is actually useful at preventing a different type of fraud. Specifically, the requestor may not be forthright with the person regarding the type of information they are requesting. If step 616 were omitted, the USR software 18 may inadvertently allow access to an unauthorized type of information in the situation where the requestor has surreptitiously requested multiple types of data.

If the USR software 18 determines that the requestor has rights to the type of data requested (616), it causes the USR database to enable access to the type of requested data (606). Otherwise, it notifies the requestor of the decision to deny access to the requested data and returns (610).

15

Various applications of the USR database **24** and USR software **18** will now be discussed in connection with FIGS. **7-16**. These applications are merely exemplary of the types of applications enabled by the USR software **18** and USR database **24**, and the invention is not limited to these particular applications.

FIG. **7** illustrates one embodiment of a method of using the USR software **18** and USR database **24** to purchase goods or services from a merchant without revealing to the merchant account information relating to the person's bank or credit card.

As shown in FIG. **7**, when a user initiates a purchase (**700**), the user enters a secret code in the user's electronic ID device (**702**) to cause the ID device to generate a onetime code or other appropriate code, and presents the electronic ID device with the code to the merchant or otherwise presents the code to the merchant. The merchant transmits to the credit card company (1) the code from the electronic ID device, (2) the store number, (3) the amount of the purchase (**704**), and the time of receipt of the code. The credit card company takes this information and passes the code from the electronic ID device to the USR software **18** (**706**). The USR software **18** determines if the code is valid, or was valid at the time offered, and if valid accesses the user's credit card information and transmits the appropriate credit card number to the credit card company (**708**). While the link between the USR system and the credit card system is a secure link, there is always a danger that the link may be penetrated and credit card numbers obtained. This may be avoided by instead transmitting, on approval, a multidigit public ID code for the credit card holder which the credit card company can map to the correct credit card number. Even if the link is violated, the public ID code is of no value and the secure link prevents this code from being improperly sent to the credit card company. The credit card company checks the credit worthiness of the user and declines the card or debits the user's account in accordance with its standard transaction processing system (**710**). The credit card company then notifies the merchant of the result of the transaction (**712**). In this embodiment, the user has been able to purchase goods or services from a merchant without ever providing to the merchant the credit card number. Since the electronic ID device generates a time variant code or otherwise generates a code that can for example only be used for a single transaction, the merchant retains no information from the transaction that may be fraudulently used in subsequent transactions.

Another embodiment of a system for facilitating purchase of goods or services without providing financial information to the merchant is set forth in FIG. **8**. In FIG. **8**, like FIG. **7**, the user initiates a purchase (**800**), enters a secret code in the electronic ID device (**802**) and presents the resultant code to the merchant. The merchant, in this embodiment, transmits to the USR software **18**, (1) the code from the electronic ID, (2) the store number, and (3) the amount of the purchase (**804**). The USR software **18** determines if the code is valid (**806**) and, if valid, accesses from the USR database **24** the user's credit card information (**808**). The USR software then transmits to the credit card company (1) the credit card number, (2) the store number, and (3) the amount of purchase (**808**). The information in this embodiment transmitted to the credit card company is intended to be in a format recognizable to the credit card company. Accordingly, the invention is not limited to transferring from the USR system **10** to the credit card company the enumerated information, but rather encompasses any transfer of information that will enable the use of the USR system **10** to appear transparent to the credit card company.

16

The credit card company then processes the transaction in a standard fashion, such as by checking the credit worthiness of the person, declining the card or debiting the user's account and transferring money to the merchant's account (**810**). The credit card company then notifies the USR system **10** the result of the transaction (**812**) and the USR software **18** in turn notifies the merchant of the result of the transaction (**814**).

In this embodiment, like the embodiment of FIG. **7**, the user can use the USR system **10** to purchase goods or services from a merchant without providing the merchant with the user's credit card number. In the embodiment of FIG. **8**, the interposition of the USR system **10** between the merchant and the credit card company is transparent to the credit card company and thus requires no or minimal cooperation from the credit card company to implement.

FIG. **9** illustrates one embodiment of a method of using the USR system **10** to verify funds when using a check to purchase goods or services from a merchant. In the embodiment of FIG. **9**, the user initiates a purchase and writes a check to the merchant (**900**). The check may be a conventional check containing identifying information, or may be a check bearing a unique serial number and no identifying information to enable the check to be used anonymously.

In either situation, the user enters a secret code into the electronic ID card and presents the resulting code to the merchant along with the check (**902**). The merchant transmits to the USR software **18** (1) the code from the electronic ID card, (2) the store number, and (3) the amount of the purchase (**904**). Where the check is an anonymous check, the merchant also transmits to the USR software **18** the check number.

The USR software **18** then determines if the code from the electronic ID is valid (**906**), and if valid accesses the user's bank information and transmits to the bank: (1) the user's bank account number, (2) the store number, and (3) the amount of the purchase (**908**). Optionally, the USR software **18** may additionally inform the bank of the check number.

The bank polls its own database to determine if there are sufficient funds in the user's account (**910**) and notifies the USR software **18** of the result (**912**). The USR software **18** then, in turn, notifies the merchant of the result of the verification (**914**).

This check verification system may take place over an unsecured connection between the merchant and the USR system **10** since the user's bank account information is not sent over the connection between the merchant and the USR system **10**. Moreover, where an anonymous check is used, the merchant is not even provided with the person's name or account information in written form. This provides additional security against unauthorized persons writing subsequent checks.

The check verification system may be conducted over a telephone network, such as by having the merchant call a toll free number or over a network connection such as over the Internet.

FIG. **10** illustrates a method of conducting a transaction with a merchant without requiring the user to provide to the merchant the user's name, address, or other identifying information, while enabling the merchant to ship the goods to the user. This may be beneficially employed, for example, in connection with transactions that take place between remote parties in a networked environment, such as the Internet.

As shown in FIG. **10**, the user initiates an anonymous purchase by entering a secret code into the electronic ID device and transmitting the result to the on-line merchant (**1000**). The merchant transmits this information to the USR software **18**, along with the store number and the amount of the purchase (**1002**). Optionally, the merchant may provide

17

the store number and purchase price to the user and the user may send this information directly to the USR software **18** along with the code from the electronic ID. Where the number from the electronic ID device is a time varying number, the merchant may also need to input the time the number was received. Alternatively, the electronic ID device may encode or encrypt the time with the number, the USR software being able to extract time when receiving the number from the merchant. This may not be required where the time varying number varies slowly, for example changing every hour rather than every minute as for some existing such devices.

In either event, the USR software **18** determines if the code is valid (**1004**) and, if valid, accesses the user's credit card information from the USR database **24** (**1006**). The USR software **18** then contacts the user's credit card company, as described above in connection with FIG. **8** (**1008**) and notifies the USR software **18** of the result (**1010**).

If the user's credit is declined, the USR software **18** notifies the on-line merchant and the transaction is terminated (**1012**). If the user's credit is honored, the USR software **18** polls the USR database **24** for the user's address and/or address code (**1014**). Address codes are discussed below in greater detail with reference to FIG. **11**. The merchant then packages the goods into a parcel, labels the parcel with the appropriate address and/or address code and ships the parcel to the user (**1016**). Having the USR system **10** provide the address and/or address code to the on-line merchant enables the user to purchase items in a networked environment without requiring the user to input address information in connection with every sale.

FIG. **11** illustrates a use of the USR database **24** to deliver mail to a user without requiring the user to provide address information to the sender. This may be useful in many contexts. For example, the user may wish that the address information be known only by the post office. In this instance, using the USR database **24** according to the method of the invention described below, will enable the user to receive parcels without requiring the user to provide the merchant with the address information. Additionally, the user's address may change, temporarily, permanently, or frequently. Enabling the sender to send mail by entering a code instead of an address enables the post office to effectively deliver the coded mail to the corresponding address regardless of the frequency with which the address changes or the duration in which the address will remain valid.

In FIG. **11**, the user provides an address code on a public area of the USR database **24** that is available to all persons to see (**1100**). This code may for example be six alpha characters, which should be adequate for currently anticipated system populations. Optionally, the user may provide this code directly to a merchant or other person desirous of sending the person one or more parcels.

The user also provides address information to the address information area **38** of the user's entry in the USR database **24** (**1102**). Access to the address information **38** is restricted by a rule or other appropriate entry in the access information **34** of the user's entry to only permit mail, parcel or other material delivery services, such as the US mail, UPS and Fed Ex to access the address information.

When someone wishes to have a parcel or other items delivered to the user, the sender retrieves the user's address code from the USR database **24** or otherwise receives the address code from the user, and prints the address code on the parcel (**1104**).

The delivery service accesses the USR software **18**, validates its identity, and queries the USR database **24** for address information corresponding to the address code (**1106**). The

18

USR database **24** retrieves the appropriate address data and provides the address information to the delivery service. The delivery service then either prints out an address label, prints a machine readable bar code to be attached to the package, or correlates an entry in a delivery database between the address code and the user address (**1110**). The delivery service then uses this retrieved information to deliver the package to the user while never supplying the merchant with the user's permanent or temporary address. A user may also assure that mail, parcels, etc. are delivered to a current location by providing only a single notice to the USR system, regardless of how frequently the person moves. The person can also automatically provide for address changes where the person moves according to a known schedule. Thus, deliveries to be made on a weekday could be directed to one address and deliveries on a weekend to another address; or deliveries during winter months to one address and during summer months to a different address.

FIG. **12** illustrates a method of enabling a person to telephone a user of the USR system **10** without providing the user's telephone number to the person. In the embodiment illustrated in FIG. **12**, the user provides a telephone code on the publicly available area of his entry on the USR database **24** (**1200**). This code may be assigned by the USR software **18** or made up by the user. The user also provides the USR database **24** with actual telephone information to enable the USR system **10** to connect callers with the user (**1202**).

The person wishing to telephone the user of the USR system **10** calls a telephone number and enters the telephone code of the user (**1204**). The USR software **18**, optionally, may require the person to identify themselves to see if they are authorized to call the user. Assuming that the person is authorized to call the person, or if no authorization check is performed, the USR connects the person to the telephone number in the USR database **24** without providing the person with the telephone number.

Enabling the user to specify the telephone number may be advantageous for many reasons. First, the user may frequently be switching between telephone coverage areas and may wish to be reachable at all times. Simply by instructing the USR database **24** to connect incoming telephone calls to one of a myriad of numbers will facilitate connecting the incoming calls to, for example, the user's cell phone, work phone, pager, car phone or home phone, without necessitating the user to provide all these numbers to the caller. A similar system may be implemented for facsimile transmissions, e-mails or other communications.

The user also may have predefined rules to enable telephone calls to follow a set pattern. For example, the user may desire to receive telephone calls only from family members during the night time at home, may wish to have all incoming calls routed to a car phone during commuting hours, and may wish to have all incoming calls routed to a cell phone during lunch. These time dependent rules may and/or caller specific rules may be entered into the USR database to specify accessibility and connectivity of incoming telephone calls.

The publicly available address code and telephone code and any other codes may be the same, or may be different, there being some advantages to having a single code usable for all such applications for each person on the system. The codes could be accessible through a variety of media including telephone and the Internet. Where two or more people on the system have the same name, which will frequently be the case, additional publicly available biographical data may be provided with the name to assure that the right code is selected. The system may similarly be used to provide public keys for use in a public key/private key encryption system, to

provide other public codes for an individual or to provide other public information. Access to such information would typically be unrestricted.

Where the system is used to provide public keys, the public code used to obtain the key, or possibly the public key itself, may be used as above to obtain the e-mail address, telephone number or the like for the person to whom the message is being sent, and the USR system may also be used to perform the encryption. When the recipient receives the message, he deencrypts it using the recipient's private key in standard fashion, including deencrypting the name of the sender. However, this does not necessarily verify the sender and such verification may be desirable for important messages, particularly ones involving large financial transactions. The USR system may accomplish such verification by also storing private keys for people in the system. The sender first authenticates himself to the system, and the system then adds a second signature to the message which is encrypted with the sender's private key. The receiving party deencrypts this signature with the sender's public key. Since the system only sends such signatures for authenticated users, the message is thus verified.

FIG. 13 illustrates a general method of using the USR database 24 to authenticate a user's identification. This may be used in connection with any of the other methods disclosed herein to ensure that the electronic ID device has not been stolen and/or hacked by an unauthorized holder.

Specifically, in the embodiment illustrated in FIG. 13, the user attempts to prove identification to a validator, such as to prove that the possessor of the electronic ID device is of sufficient age to purchase alcohol (1300). In connection with this attempt, the user enters a secret code into the electronic ID (1302). The validator transmits to the USR software 18 the code from the electronic ID (1304). If the USR software 18 determines that the code is valid (1306), it accesses the user's photograph, age information, or any other desired information, and transmits that information to the validator (1308). By transmitting back to the validator a picture of the person to whom the electronic ID card was issued, the validator can ensure that the person using the electronic ID card is the proper person. Likewise, the validator can ensure, based on the information provided by the USR system 10, that the person is as old as the person claims to be.

A specific embodiment of this identification validation procedure is illustrated in FIG. 14. In FIG. 14, a policeman takes the place of the validator. In this scenario, however, instead of simply transmitting to the policeman a validation of the user's identity, such as their picture, the policeman may also receive additional information, such as the user's police records, records of any arrests, outstanding warrants, and other similar information that may be of use to the policeman when determining how to handle a particular individual.

FIG. 15 illustrates a process for enabling the user to provide specific information to a party, such as medical staff in an emergency room. As shown in FIG. 15, if the user desires to provide information to a party (1500), the user enters a secret code in the electronic ID device and provides the electronic ID code to the party (1502). The party transmits to the USR software 18 the ID code and the party code (1504). The party code may be a code from for example an electronic device which identifies the party, may be a status code which identifies the class of users to which the party belongs, for example policeman, emergency room personnel, doctor, etc. or may be a combination of both, the status code for example being encrypted into the ID code. The USR software 18 determines if the code is valid (1506), accesses the user's information in the USR database 24 and transmits available

information to the party (1508). In this scenario, the user may be provided with a plurality of different codes to enter into the electronic ID device depending on the type of information to be released to the party. For example, the user's basic code may be 1234. The fifth digit of the electronic code may specify the type of information to be provided, i.e., 1=address information, 2=medical information; 3=telephone information, 4=job application information, etc. Using multiple codes eliminates any ambiguity about the authority provided by the user to the party, but requires the user to remember additional information.

The above assumes the user is able to provide an ID code when the information is required. However, in for example an emergency room situation, the user may not be in a position to provide the ID code, but would still want medical records provided. The release authorization for certain portions of the user's database could therefore specify that the information be released to certain class or classes of individuals and the USR system would release such information to individuals or organizations based only on status code. Thus, the status code of an emergency room could alone trigger release of medical data.

FIG. 16 illustrates one embodiment of a method of using the USR database 24 to complete a standard application, such as a job application or an application to rent an apartment. This embodiment is a specific example of the more generic method of enabling a party to retrieve information discussed above with respect to FIG. 15. In FIG. 16, however, the party may be provided with the opportunity to provide a form to the USR software 18, the fields of which may be automatically completed with information from the job application information section of the USR database 24.

As can be seen from the above, many of the users of the USR system are organizations or agencies such as carriers (post office, UPS, FedEx), communication companies, law enforcement organizations, hospitals and other medical facilities and the like. Each of these organizations can be provided with specialized software either on a disc or other suitable media or electronically, for example over the Internet, which performs a number of functions, for example automatically generating status codes for data access requests, controlling information received, and formatting data received in response to a request in a desired way. This can result in an access request from such organization for a given user causing all data on the user required to complete the form being retrieved and presented to the organization in the format of their form. A user may also authorize an organization for which a form has been completed using the USR system to receive updates, either in response to a request from the organization or at selected intervals, for example once a year, so as to maintain information in the forms current. Since the user will be providing information to the system on a regular basis, this is a relatively easy and painless way for the user to maintain current information with many organizations the user deals with.

Another potential use of the system is to permit a person to be located where only limited biographical information on the person is known. Users of the USR system wishing to participate in this feature could be cued to provide non-confidential biographical data when they come on the system or at any time thereafter when they decide to participate. They can also indicate whether they wish their name given out in response to such an inquiry or to merely be alerted to an inquiry which might involve them and information on the requester. A person seeking to find another person or group of people can input appropriate biographical data, for example members of 1975 Harvard University hockey team, or infor-

mation of a person's last known address plus school information, etc. The system will then provide a list of persons who meet the listed criteria from which the person making the inquiry can hopefully find the person they are looking for.

In the above application and others, when a person is located, the person may request that only the person's address code or general access code (i.e. a single code which is used to get current address, telephone, e-mail, etc. information) be provided when the person is located. This can further protect the individual from undesired contacts.

Further, although each of FIGS. 13-16 refer to the entry of a secret code for validation by the USR system, the processes illustrated for each of FIGS. 13-16 may include a challenge-response protocol by which the user's identity is authenticated.

FIG. 17 illustrates another embodiment of the invention. As shown in FIG. 17, the USR system 10 may be used to secure expensive personal equipment, such as stereos, televisions, laptop computers, cellular telephones, cars, boats, and other items of value to a person. In this embodiment, each item to be secured using the USR system is provided with a USR timer chip imbedded in the electronics. If the USR timer chip is not provided with a code within a predefined period of time, for example every 30 days, the equipment is deactivated. Thus, for example, a television, mobile phone, laptop computer, automobile, heavy equipment, weapon or facility may be provided with a security chip having an internal timer that must be reset before expiration by provision of a particular code. When reset does not occur, the timer will disable the electronic device or other device using any one of a number of known disablement methods. Exemplary codes may be transmitted in the same manner as beeper signals are conventionally transmitted or may be transmitted to wired devices over the Internet or other public network.

The USR system 10 may be advantageously employed to automatically provide the secured property with the necessary codes at appropriate intervals, unless instructed by the user of the USR system 10 to cease doing so. Alternatively, the USR system 10 may require participation by the user prior to sending out the activation codes.

In this embodiment, the user may provide to the USR system 10, information indicative of the codes to be transmitted, timing information, and automation information—i.e., whether the codes should be sent automatically or should require user intervention. Optionally, where the user opts to require user intervention, the USR system 10 may notify the user of the upcoming deadline via e-mail or another method.

This system may be useful to secure sensitive equipment other than personal equipment as well, such as military equipment, public equipment, school equipment and any other equipment that is subject to theft.

FIG. 18A illustrates another embodiment of the invention that can provide a centralized system to control access to a plurality of secure networks. As shown in FIG. 18A, for example, a system 1800 may employ the USR 10 to control access to a plurality of secure systems 1804 (e.g., a plurality of secure computer networks). The system 1800 may include one or more access devices 1802 that can be employed by a user to access a secure computer network included in the plurality of secure systems. In addition, the system 1800 may be employed to protect other secure systems such as secure communication networks and/or other resources that are accessed electronically. According to one embodiment, the system 1800 includes a first communication link 1801 that provides a communication path between the access device 1802 and the USR 10, and a second communication link 1803 that provides a communication path between the USR 10 and

the plurality of secure system 1804. In one embodiment, each of the first communication link 1801 and the second communication link 1803 are wide area networks, for example, the Internet.

Each of the secure systems 1804 can be associated with an organization. An organization is any entity that employs a secure (e.g., restricted access) host system to provide resources to a plurality of users. For example, an organization may be a corporation (including a non-profit corporation), partnership, other business entity, an affiliation or individual that employs a secure host system to provide resources to a plurality of authorized users. As should be apparent to those of ordinary skill in the art, an organization is not restricted to any particular size, for example, as measured by the number of members or employees.

More specifically, each of the secure systems No. 1, No. 2, No. 3, etc. may be associated with a different organization and the USR 10 may control access to each of the secure systems. That is, the USR 10 can provide access control for a plurality of secure computer networks each associated with a different and unrelated organization. Further, each of the secure computer networks may have a different plurality of users who are authorized to access the network.

The access device may include any of a desktop computer, a laptop computer, and a handheld computer (e.g., a PDA, call phone and the like). Further, as shown in phantom, a plurality of access devices may communicate with the USR 10. Where a web-based system is employed, for example, each of a plurality of computers connected to the Internet may be individually employed as a separate access device to communicate (e.g., independently communicate) with the USR 10 to gain access to one or more of the secure systems 1804.

For example, the access device 1802 may be a computer employed with a client-server network. In this example, to access resources provided by one of the secure system 1804, the user initiates an access request for a secure system 1804 selected by the user. That is, the user may supply authentication information and a computer network ID to the USR. As is described in further detail below, the authentication information and the computer network ID are processed by the USR to authenticate the user and determine whether the user is authorized to access the secure system 1804 that is identified by the computer network ID. The USR then routes communications between the user and the secure system provided that the user authentication is successfully completed.

According to one embodiment, the USR 10 connects the access device 1802 to one of the secure systems 1804 via a communication path that does not include the USR 10. In an alternate embodiment, the USR 10 connects the access device 1802 to one of the secure system 1804 via a communication path that does include the USR.

Referring now to FIG. 18B, a system 1810 employs a USR 10 to control access to a secure system (e.g., a secure computer network) according to another embodiment. In one embodiment, the system 1810 includes the USR 10, an access device 1802, and a plurality of secure system 1804. According to this embodiment, the user selects from the plurality of secure systems 1804 a secure system that the user would like to access. With the access device 1802, the user communicates authentication information directly to the selected secure system 1804, e.g., without gaining access to the system. The secure system then communicates the authentication information and/or information corresponding to the authentication information to the USR 10. The USR 10 processes the information received from the secure system and then communicates an indication of whether the authentication information corresponds to one of the plurality of users

authorized to access the secure system. The secure system grants or denies access to the secure system (and the associated resources) based on the indication received from the USR 10.

As illustrated in FIGS. 18A and 18B, the USR 10 can provide a centralized access control system (e.g., an authentication system) for a plurality of secure systems 1804 that are associated with independent organizations that may have no affiliation with one another. Referring to FIGS. 18A and 18B, a first organization may be associated with (have resources located on and/or accessed by) the secure system no. 1, a second organization may be associated with the secure system no. 2, and so on. In addition, a single organization may also be associated with a plurality of the secure systems 1804. Thus, in one embodiment, the USR 10 provides access control to a plurality of secure systems for a single organization.

The systems 1800 and 1810 allow an organization to operate a secure system without hosting the authentication system software or at least without the need to host a substantial part of authentication system software. Thus, in one embodiment, software upgrades/maintenance can be implemented at the USR 10 (e.g., centrally) for the plurality of secure systems 1804 and specialized authentication software is not required at the access device. In a further embodiment, specialized authentication software is also not required at the secure system. In versions of these embodiments, the USR 10 provides a web-based system in which the user employs a web-browser when communicating with the USR 10 and the secure system.

The USR 10 can also provide centralized administration and management for the plurality of secure systems 1804. The centralized administration can include routine tasks such as adding or removing authorized users for each of the plurality of secure systems 1804, for example, based on the hiring or resignation, respectively, of an employee. Additional administrative functions such as maintaining a secure database of private keys associated with each user, generating time varying codes, maintaining encryption software, maintaining audit trails and other functions may also be accomplished in a centralized fashion with the USR 10 for a plurality of organizations.

In one embodiment, following the connection of the access device 1802 to the secure system 1804, the USR 10 develops an audit trail by monitoring the communication path to capture information concerning the use of the secure system. For example, the USR 10 may collect and store information concerning the length of time during which the access device remains connected to the secure system, the type of resources accessed by the user, the type of data transmitted (including the identification of specific documents) during a login period and the volume of data transmitted.

According to one embodiment, the USR continuously monitors the communication between a plurality of access devices 1802 and a secure computer network and collects information to generate an audit trail for each device. According to another embodiment, the USR does not continuously monitor communications. Instead, the secure computer network intermittently (e.g., periodically) transmits audit information to the USR 10 where the audit information may concern one or a plurality of users connected to the network during a specific time period.

In each of the embodiments, described with reference to FIGS. 18A and 18B, the USR 10 may be located in an ultra-secure facility that employs heightened security relative to the security provided by the organizations that it serves. The physical facility where the USR is located may meet requirements generally associated with critical military installations.

For example, the USR 10 may be housed in a facility that is hardened against radiation, shielded against electromagnetic interference, and/or protected against earthquakes, hurricanes, etc. to allow operation of the USR during times of general emergency. Further, the personnel and hiring policies of the facility operating the USR 10 may also be more secure relative to the security measures taken by the organizations associated with the secure systems 1804. That is, the individuals operating the USR 10 may undergo more rigorous background checks that include a detailed investigation of their personal and employment histories.

The centralized approach described above can provide increased security because the administration of the access control system (e.g., authentication software) is in the hands of a highly trusted third party who has taken heightened security measures regarding the hiring of the administrative personnel, in particular, the personnel who have access to authentication data (e.g., private encryption keys, etc.).

In any of the preceding embodiments, the USR 10 may be geographically remote from the secure systems.

Further, in any of the preceding embodiments, there may be situations where a user employs the access device 1802 to connect to more than one of the plurality of secure systems 1804. In one embodiment, the user is independently authorized to access separate secure systems 1804 associated with independent organizations. In another embodiment, the user is authorized to access separate secure systems 1804 each associated with the same organization. In either situation, the user may employ one or more of the authentication procedures described herein before being allowed access to any one of the secure systems 1804.

Referring now to FIG. 19, a process 1900 that employs a USR to control access to a secure computer network is illustrated. In one embodiment, the process 1900 is employed with the system 1800 illustrated in FIG. 18A. At step 1902 an entity initiates an access request. In general, the access request will be initiated when the user or entity inputs information into an access device such as a computer. At stage 1904, the entity supplies authentication information and a computer network ID to the USR (e.g., the information is electronically transmitted from the access device to the USR). According to one embodiment, the information is transmitted via the Internet from the access device to the USR. At stage 1906, the USR receives the access request which includes the authentication information and the computer network ID. At stage 1908, the USR determines whether the authentication information is valid for a user. According to one embodiment, the USR includes a database containing selected data of a plurality of users authorized to access a secure computer network, and may compare the authentication information supplied by the entity with authentication information included in the database to determine whether the authentication information corresponds or is valid for a user. If the authentication information is valid, the process 1900 moves to stage 1910 where the USR determines whether the entity is authorized to access the computer network identified by the computer network ID. If the entity is authorized to access the computer network then the USR may allow communication between the entity and the secure computer network at stage 1912. As previously indicated, the USR may route communications between the entity and the secure computer network and remain in the communication path employed by the access device to communicate with the secure computer network. Alternatively, the USR may simply provide a connection between the access device and the secure computer network where the communication path provided by the connection does not involve the USR.

25

Returning to stage **1908** if the authentication information supplied by the entity is not valid for any of the plurality of users then the process **1900** moves to stage **1914** where an indication is provided to the entity that access is denied. Similarly, if at stage **1910** the entity is not authorized to access the computer network identified by the computer network ID, an indication is provided that the entity is denied access at stage **1914**. In various embodiments, the entity may be allowed additional opportunities to successfully access the system.

Referring now to FIG. **20**, a process **2000** for controlling access to a secure computer network is illustrated in accordance with one embodiment. In one embodiment, the process **2000** is employed with the system **1810** illustrated in FIG. **18B**.

In one embodiment the entity initiates an access request at stage **2002**. As described above, the access request can be initiated using an access device and each secure computer network may communicate with a plurality of access devices. At stage **2004**, the entity supplies authentication information to the secure computer network, for example, by entering the information in a web browser and transmitting the authentication information over the Internet to the secure computer network. At stage **2006**, the secure computer network receives the authentication information. At stage **2008**, the secure computer network communicates authentication information to the USR (or information corresponding to the authentication information) to allow the USR to authenticate the access request. At stage **2010**, the USR validates the authentication information to determine whether the entity is authorized to access the secure system, and at stage **2014**, the secure system receives an indication from the USR concerning whether the entity is authorized to access the system. In one embodiment, the indication is transmitted from the USR to the secure system via the Internet. At stage **2016**, the secure system grants or denies the entity access to the secure system based on the indication received from the USR.

As should be recognized by those of ordinary skill, the processes **1900** and **2000** can be accomplished in a variety of stages that may include any of the stages described above in various combinations and sequences including one or more of the stages described above in combination with one or more additional stages.

Various embodiments can be employed to control access to a physical facility. That is, an electronic device (e.g., a keypad, a card reader, a biometric scanner, etc.) or combination of electronic devices can be located at an access point to a secure area (e.g., a door, a gate, etc.). The entity initiates the request using the electronic device. In one embodiment, the physical facility includes all or a portion of the secure computer network. Thus, in one embodiment, the secure system receives an indication of whether an entity is authorized to access a physical facility. The secure system communicates authentication information to the USR. The USR validates the authentication information and communicates an indication of whether the entity is authorized to access the physical facility. The secure system receives the indication and grants or denies the entity access to the physical facility.

Each of the embodiments described with reference to any FIGS. **18-20**, may include a challenge-response protocol, for example, to authenticate the identity of the entity and/or the USR system to the other.

FIG. **21** illustrates an embodiment of a system **2100** for validating the identity of an individual or an entity. The system includes a first wireless device **2110** and a second wireless device **2112**. The first wireless device **2110** comprises a first wireless transmitter and receiver **2114**, a first processor

26

2116 and a first memory **2118**. Similarly, the second wireless device **2112** comprises a second wireless transmitter and receiver **2120**, a second processor **2122** and a second memory **2124**. According to aspects of the invention, the first wireless device and the second wireless device are configured to wirelessly communicate with each other so that the entity associated with the first wireless device can communicate his identity to the entity associated with the second wireless device. It is to be appreciated that the first wireless transmitter and the second wireless transmitter can be configured to communicate by any form of a wireless signal such as low power Bluetooth signal, infrared signals, RF signals and electromagnetic signals in general. In accordance with one embodiment, the first wireless device and the second wireless device communicate via near field signal.

The first wireless device can also comprise user interface **2126** that allows the first entity to interact with the first wireless device and can also comprise a display, such as a LCD display, **2118** that allows the first entity to further interact with the first wireless device. In accordance with some embodiments the invention, the first wireless device can be configured so that the first entity must enter a PIN identification number, for example, via the user interface to gain access to the wireless device. Alternatively, or in addition, the first wireless device may comprise a biometric sensor or detector **2130** that enable the first entity to present biometric data to the first wireless device to gain access to the first wireless device. For example, the biometric sensor can be configured to detect a fingerprint of the first entity. For such embodiment, the memory **2128** also comprises stored biometric data of the first entity, which is compared, for example, by the processor **2116** with the detected biometric data to determine whether the first entity is enabled or should be disabled from using the first wireless device. It is also to be appreciated that the biometric data need not be fingerprint data and can be any biometric data known to those of skill in the art, and that the biometric sensor need not be a fingerprint sensor and can be any biometric sensor known to those of skill in the art.

Similarly, the second wireless device **2112** can also be configured as discussed above with respect to the first wireless device, namely with any or all of a user interface **2132**, a display **2134** and a biometric sensor **2136** and can be configured to require any and/or all of a second entity to provide a PIN number, or the second wireless device to match biometric information of the second entity with stored biometric information to enable or disable the second entity to gain access to the second wireless device. Each of the first wireless device **2110** and the second wireless device **2112** comprise a power source or a power source interface **2138**, **2140** that can be coupled to a power source that provides power to respective devices. It is to be appreciated that the power source can be any power source, such as, alkaline batteries, rechargeable batteries, proprietary power sources, and interfaces to power sources such as standard 120 VAC, or an AC to DC conversion device, as well as any other type of power source known to those of skilled in the art. In addition, it is to be appreciated that each of the first wireless device **2110** and the second wireless device **2112** can also comprise an additional wireless transmitter and receiver device **2142**, **2144**, respectively, which enable each of these devices to communicate wirelessly via other wireless communication systems such as, via any cell phone standard, via satellite communications, over wireless area networks, local area networks, wide area networks, as well as any other wireless communication standard known to those of skill in the art.

According to some embodiments of the system **2100** of FIG. **21**, either or both of the first wireless device **2110** and the

second wireless device **2112** can be configured to communicate with a secure database **2146**, as will be discussed in further detail herein. According to some embodiments, either of the first or second wireless devices may communicate with the secure database on a periodic basis to update its corresponding data, or to stay alive as will be discussed herein, or to retrieve information in the secure database that is used in the communication protocol between the first and second wireless devices to verify the identity of at least the first entity. Accordingly, it is to be appreciated that communication with a secure database can be, for example, via the additional respective wireless transmitters and receivers **2142**, **2144** of the first and second wireless devices, or can be via a network interface **2152**, **2154** of the respective devices, that communicate with a network **2148** and to the secure database **2146**.

Referring now to FIG. **22**, there is illustrated one embodiment of an overall communication process that occurs with the system **2100** of FIG. **21**. In particular, the process is effected by the system of FIG. **1** so as to identify and authenticate the identity of the first user associated with the first wireless device **2110** to the second user associated with the second wireless device **2112**. For example, consider the situation where an air marshal or an FBI agent is carrying the first wireless device **2110** and airport security or security personnel generally want to ensure the identity of the user of the device **2110**. The communication protocol **200** illustrated in FIG. **22** is one embodiment of a protocol that enables secure authentication of the first user of the wireless device **2110**.

According to one embodiment of the process, the first user of the first wireless device **2110** first authenticates his or herself to the wireless device **2110**, for example as has been discussed above, by either entering a PIN via the user interface **2126** of the first wireless device or by interacting with the biometric sensor of the first wireless device at step **202**. In various embodiments, a challenge-response protocol is employed in which the first user supplies information (a biometric, a PIN or other information) to authenticate his or herself to the wireless device **2110**. If the user of the device does not enter the correct PIN number or does not match the biometric data stored in memory **2118** of the first authorized user of the device, then the device at a minimum shuts down at step **204**. However, according to some embodiments, the device **2110** can also be configured to automatically delete any portion of or all of the data stored in memory **2118** at step **206**. In addition, as will be discussed in further detail herein, according to some aspects of the invention, the first wireless device can be configured to periodically communicate with the secure database **2146** to remain alive, for example, after the first user of the first device authenticates itself to the first device. If the first device does not communicate with the secure database at such periodic intervals at step **208**, then the first device can be configured to delete any or a portion of the data stored in memory at step **206**.

The communication protocol also comprises a second user of the second device to authenticate his or herself to the second device at step **210**. It is to be appreciated that the authentication by the second device of the second user by any of the mechanisms discussed herein and above with respect to the first wireless device, including entering a PIN number to the user interface **2132** of the second wireless device or by interacting with the biometric sensor **2136** of the second wireless device. In addition, it is to be appreciated that as discussed above with respect to the first wireless device, if such identification is not successful, the second wireless device will at a minimum shut itself down at step **212**. However, it is also to be appreciated that the second wireless device can be configured to automatically delete a portion of

or all of the data stored in the memory **2124** of the second wireless device, should such authentication not be successful at step **214**. In addition, it is to be appreciated that the second wireless device can also be configured at step **216** to communicate with the secure database **2146** within defined periods of time, or even a periodic interval once the second user authenticates himself to the second wireless device, and to delete a portion of or all of the data in memory **2124** should such periodic communication not occur.

If both the first user and the second user are successful in authenticating themselves to the first and second wireless devices respectively, then a communication protocol is initiated between the first wireless device **2110** and the second wireless device **2112** at step **218**. If the communication protocol is not a valid communication protocol between the devices, the devices wait until there is a valid communication protocol. If the communication protocol is a valid protocol (**218** yes), then the first wireless device transmits a first wireless signal containing encrypted authentication information of the first user to the second wireless device **2112** at step **220**. The details of the communication protocol and the encrypted authentication information will be discussed further herein.

The second wireless device **2112** receives the first wireless signal and processes the wireless signal to determine the identity of the first user. In particular, as will be discussed herein, according to some aspects of the invention, the authentication of the first user includes displaying a picture of the first user to the second user on the display **2134** of the second wireless device as a result of the communication from the first wireless device to the second wireless device. The user of the second wireless device can view the picture on the display and ascertain whether the first user of the first wireless device is who he or she purports to be. However, as will also be discussed herein, it is to be appreciated that the second wireless device need not be a device that requires a user to interact with it and can be, for example, an unmanned detection system that receives the first encrypted authentication information and determines from the first authenticated encrypted information whether the first user is authorized to gain access to a secured place, a secure network, or a secure computer, to do whatever the first person is seeking to do. If the first user is not who they purport to be, the communication process goes back to looking for a valid communication protocol. In addition, the process allows the second user or the system associated with the second wireless device to take an appropriate action such as denying access to the secure site at step **224**.

If the user of the first wireless device is authenticated (at step **222** yes), then according to some aspects of the invention, the communication process allows for the second wireless device to transmit a second wireless signal comprising encrypted authentication information of the second user to the first wireless device at step **226**. In addition, according to such aspects, the communication protocol and the first wireless device are configured to authenticate the identity of the second user to the first user at step **228**. It is to be appreciated that the authentication of the second user to the first user can be in any of the manners discussed above with respect to the authentication of the first user of the first device, such as by viewing a picture of the second user as provided on the display **2128** of the first wireless device, by matching one-time information contained in the encrypted authentication information or via a challenge-response protocol.

In addition, according to some embodiments of the protocol, either or both of the first wireless device **2110** and the second wireless device **2112** may communicate with the secure database **2146** to retrieve additional information at

step **230**. Such information, as will be discussed herein, can include for example, a portion of the biographic data of the first user of the first wireless device or of the second user of the second wireless device, or full biometric information of the first user or the second user, which can be communicated back to the respective device and used by the respective device to authenticate the user. In addition, the information can be periodic updates as provided the secure database to the respective device, such as will be described herein, including periodic updates of public keys of a plurality of first users as stored in memory on the second wireless device, or updates to public keys of a plurality of second users as stored in memory on the first wireless device. In addition, such information may include periodic updates of the biometric information of a plurality of first users as stored on the second wireless device or a plurality of second users as stored on the first wireless device, which can comprise for example a portion of the biometric information or all of the biometric information.

Referring now to FIG. **23**, there is illustrated one embodiment of various fields included within the first wireless signal and the second wireless signal as transmitted between the first wireless device and the second wireless device. According to some embodiments, the signal comprises a header field **302**. The header field can be any header field known to those of skill in the art. In addition, the signal comprises a public ID field **304**, which can comprise, for example, any of name information, a badge number, an employee number, an e-mail address, a social security number, and the like, of the first user. In addition, the first wireless signal may also include a digital signature field **306** containing a digital signature of the first user. For example, the digital signature may be generated with the user's private PKI key. Further, the first wireless signal may comprise a one-time time varying code field **308** that includes a random code as generated by the first wireless device. According to some embodiments, the digital signature field and the one-time code field can be used, for example by the second wireless device, to allow access to a secure place without the need for a user of the second wireless device to interact with the second wireless device to authenticate the first user. As an example, referring to FIG. **24**, the digital signature and one time code can be encrypted with the private key of the first user and transmitted to the second wireless device. The second wireless device can decrypt the digital signature and one time code with the public key of the first user at steps **402-404** to authenticate or not the first user at step **406**.

In addition, referring back to FIG. **23**, the first wireless signal also comprises a PKI encrypted one-time DES key field **310** comprising a PKI encrypted one-time DES key. Further, the first wireless signal comprises a DES key encrypted biometric data field **312**, which includes at least a portion of biometric data of the first user encrypted with the DES key. As will be discussed in further detail herein, according to some aspects of the invention, the public key of a first user, for example, stored in memory **24** of the second wireless device can be used to decrypt the DES key, and the DES key can be used to decrypt at least a portion of the biometric data of the first user to use in the authentication of the identity of the first user. According to some embodiments, the first wireless signal can also comprise another ID data field **314**, which can contain other information such as name, height, weight, eye color or anything else.

It is to be appreciated that although the embodiment of the wireless signal discussed in FIG. **23** has been discussed with reference to the first wireless signal transmitted from the first wireless device **2110** of FIG. **21** to the second wireless **2112**, that the same protocol can be used when transmitting a second

wireless signal from the second wireless device **2112** to the first wireless device **2110** to authenticate the identity of the user of the second wireless device to the user of the first wireless device. It is to be further appreciated that various fields of the signal can be used and not all of the fields of the wireless signal are needed to authenticate identity of the user.

Referring now to FIG. **24**, there is illustrated one embodiment of a process **400** as identified by act **222** in FIG. **22** for verifying or authenticating the identity of the first user of the first device. According to this embodiment, which has been briefly discussed herein with respect to FIG. **23**, the second wireless device can verify the identity of the respondent without necessarily interacting with a second user by decrypting the first user's digital signature from the digital signature field **306** at step **402** and verifying that it is the digital signature of the first user, decrypting the one-time code from the one-time code field **308** at step **404**, and using this information at step **406** to authenticate the first user. If the first user is authenticated at **406**, an appropriate action such as allowing access to the secure site, or computer, or network can be granted.

Referring now to FIG. **25** there is illustrated another embodiment of a process **520** for authenticating the identity of the first user at step **222** of the communication process of FIG. **22**. According to aspects of the invention, the second wireless device at step **522** receives the first wireless signal and extracts the PKI encrypted DES key from field **310**. The wireless device looks up the public key of the first user from memory **2124** [See FIG. **21**] or from a secure server based on the information provided in the public ID field **304** at step **524**. The second wireless device uses the first public key to decrypt the PKI encrypted DES key at step **526**. The second wireless device acts on the DES key encrypted biometric information from the field **312** and uses the decrypted DES key to decrypt the at least a portion of the biometric information of the first user as included in the first wireless signal at step **528**.

According to some embodiments, the biometric information included in the first wireless signal is a portion of the biometric information of the first user and the second wireless device is configured to store a remainder of the biometric information of the first user in memory. According to such embodiments, the process **520** also comprises looking up the remainder of the biometric information stored in the memory at step **530** and combining the remainder of the biometric information with the decrypted and extracted biometric information to provide complete biometric information of the first user at step **532**. According to some aspects of the invention, the biometric information can comprise a digital image of the first user and for such aspects, the digital image can be displayed on display **2134** of the second wireless device so that the second user can ascertain whether the first user associated with the first device is who he or she purports to be. However, it is to also be appreciated that the biometric information can be fingerprint information, a voiceprint, DNA codes of the first user, or any other biometric information known and used by those of skill in the art. Accordingly, the processor **2122** of device **2112** can also be configured to process the combined biometric information to authenticate the first user at step **536**.

Referring now to FIG. **26**, there is illustrated another embodiment of a process **620** that can be used to authenticate the identity of the first user at step **222** of the process **200** of FIG. **22**. According to this embodiment, some of the steps are similar to the steps of the process **520** illustrated in FIG. **25** and accordingly a full description of these steps will not be herein duplicated. It is to be appreciated that this embodiment can be used for example, where the biometric information of

the plurality of first users is not stored on the second wireless device 2112 but is instead stored at the secure database 2146 as illustrated in FIG. 21. In particular, for highly secure applications, where there is a worry that the second wireless device can be compromised (even with the necessity to authenticate the second user to the second wireless device), the second wireless device can be configured to interact with the secure database to obtain at least a portion of the biometric information of the first user, rather than storing at least a portion of the biometric information of the first user in memory on the second wireless device.

According to such embodiments, the second wireless device can receive the first wireless signal including the fields discussed above in respect to FIG. 23, in particular, the public ID field 304 and optionally the PKI encrypted DES key. According to some embodiments, the PKI encrypted DES key may be used by this process. At step 624, the second wireless device accesses public key information of the first user from the public keys stored in memory on the second wireless device. However, it is to be appreciated that in some embodiments, the public keys may not be stored on the second wireless device and for such embodiments, the second wireless device will communicate with the secure database to obtain the public key of the first user also at step 624. According to some embodiments, at step 626 the second wireless device transmits a signal to the secure database comprising public identification number to identify the second device to the secure database, presumably after the second user of the second device has authenticated his or herself to the second device. For such embodiments, at step 628, the secure database determines whether the second device is authorized to access the secure database at step 628. It is to be appreciated that according to some embodiments, this communication between the second wireless device and the secure database can be accomplished with encrypted signals and in some embodiments the encrypted signals can include using time varying one time codes to further secure the communication. If the second device is authorized to interact with the secure database, the process also comprises transmitting the first public ID from the second wireless device 2112 to the secure database at step 630, and with this information, the secure database accesses the biometric or identification information of the first user at step 632. The biometric or the at least a portion of the biometric information can then be transmitted by the secure database to the second wireless device at step 634. Again, this transmission can be encrypted and further include time varying or one time codes to further secure the communication. The second wireless device can use the received portion of the first biometric information and combine it with portion of the first biometric information provided in the first wireless signal, or can receive all of the first biometric information as provided by the secure database and, for example, display it on the display 2134 of the second wireless device 2112 at step 636, or can process the biometric or identification information at step 638 to determine whether the first user is authenticated.

Referring now to FIG. 27 there is illustrated one embodiment of a data structure 720 that can comprise memory 2124 of the second wireless device 2112. It is to be appreciated that any or all of the various portions of this data structure can be present in the memory 2124. According to some aspects of the invention, the memory will include the private key of the second user at field 722. The private key can be used, for example, when communicating by the second wireless device to the first wireless device to provide a digital signature of the second entity encrypted with the second user's private PKI key to the first user. In addition, the memory can also com-

prise a plurality of public keys of a plurality of first users at area 724. Such public keys of a plurality of first users can be used as has been discussed herein in combination with the private key of the first user to decrypt information of the first user. For example, the public and private key can be used to decrypt the DES key of the first user. In addition, the memory can also comprise at least a portion of biometric data of a plurality of first users, at area 726. As been discussed herein, the at least a portion of the biometric data of the plurality of first users can be combined with the portion of the biometric data provided in the first wireless signal or from the secure database, to create the complete biometric data of the first user for ascertaining or authenticating the identity of the first user as has been described herein. In addition, the memory can also comprise biometric data of the second user at field 728. The biometric information of the second user can be used, for example, as has been discussed herein to compare the biometric data detected by the biometric sensor 2136 of the second wireless device to determine whether the second user is authorized to have access to the second wireless device. It is to be appreciated that the data structure 720 of FIG. 27 can also comprise the memory 2118 of the first wireless device 2110, and that any or all of the fields of the data structure 720 can exist in the memory 2118 in the first wireless device. It is also to be appreciated that the first wireless device can access the data structure 720 and the various fields for the same purposes as discussed above with respect to the second wireless device, namely, to provide the first digital signature of the first entity encrypted with the first private key in the first wireless signal, to access the public keys of a plurality of second users for the purpose of decrypting information provided in the second wireless signal, to access at least a portion of biometric information of the second user stored in the field 726, as well as to compare biometric information of the first user with sensed biometric data provided by the biometric sensor 2130 of the first wireless device.

In one embodiment, the method comprises acts of receiving first authentication information about the first entity with the first device, transmitting the authentication information about the first entity to a secure database, determining whether or not the first entity is allowed to access the first device based on the first authentication information, and transmitting an enablement signal to the first device indicating to enable nor not enable the first entity to access the first device. According to a further embodiment, the method also includes an act of allowing or not allowing operation of the first device based on the enablement signal. In another embodiment, the act of receiving the first authentication information of the first entity comprises receiving biometric information of the first entity by detecting the biometric information with the first device.

In yet another embodiment, the act of transmitting the first authentication information about the first entity to a secure database comprises generating a non-predictable signal from the biometric information. In a further embodiment, the act of generating the non-predictable signal from the biometric information comprises generating a time varying non-predictable signal from the biometric information. In a still further embodiment, the act of receiving biometric information of the first entity comprises receiving a voice signature of the first entity with the first device and the act of generating the non-predictable signal from the biometric information comprises mixing the voice signature of the first entity with a random code to generate the non-predictable signal. In yet a further embodiment, the act of transmitting the enablement signal to the first device comprises sending the random code

to the first device. In a still further embodiment, the act of receiving biometric information of the first entity comprises receiving fingerprint data of the first entity with the first device and the act of generating the non-predictable signal from the biometric information comprises mixing the fingerprint data of the first entity with a random code to generate the non-predictable signal. In another embodiment, the act of transmitting the enablement signal to the first device comprises sending the random code to the first device.

In a further embodiment, the act of authenticating the biometric of the first entity comprises authenticating a voice signature of the first entity. In another embodiment, the act of authenticating the biometric information of the first entity comprises authenticating a finger print of the first entity.

In one embodiment, a first wireless device includes a biometric detector comprising a fingerprint detector that detects a fingerprint of the first entity. In an alternate embodiment, the biometric detector comprises a voice signature that detects a voice signature of the first entity.

According to one embodiment, the system comprises a first wireless device including a processor configured to enable operation of the first wireless device if it receives an enablement signal validating first biometric information of a first entity and configured to generate a non-predictable signal from the biometric information, a first wireless transmitter and receiver configured to transmit a first wireless signal including first encrypted biometric information of the first entity and to receive the enablement signal, a first biometric detector for detecting the first biometric information of the first entity and a secure database configured receive the first wireless signal, to authenticate or not authenticate the first biometric information of the first entity, and to provide the enablement signal validating or not validating the first biometric data of the first entity.

In a further embodiment, the secure database further comprises biometric data of a plurality of first entities. In another embodiment, the processor is configured to generate the non-predictable signal from the biometric information by generating a time varying non-predictable signal from the biometric information. In a still further embodiment, the processor is configured to generate the non-predictable signal from the biometric information by mixing the biometric information of the first entity with a random code to generate the non-predictable signal. In yet another embodiment, the secure database is configured to transmit the enablement signal to the first device including the random code so as to authenticate the secure database to the first device. In still another embodiment, the system includes a memory for storing a private key of the first entity authorized to use the first device.

It should be understood that various changes and modifications of the embodiments shown in the drawings and described in the specification may be made within the spirit and scope of the present invention. Accordingly, it is intended that all matter contained in the above description and shown in the accompanying drawings be interpreted in an illustrative and not in a limiting sense. The invention is limited only as defined in the following claims and the equivalents thereto.

FIG. 28 illustrates an embodiment of a system 100 that employs a converter device 102 to provide an interface between a user device 104 (e.g., a transaction card, a cell phone, etc.) and a system interface 106 where, for example, the system interface 106 employs a magnetic card reader and the user device 104 is not equipped with a magnetic stripe. That is, in one embodiment, the converter device 102 provides a mode of information transmission between the user device 102 and the system interface 106 which would otherwise be unavailable to the user device 102. The converter

device 102 provides a modified system 100 that provides compatibility with a greater variety of user devices, for example, user devices such as transaction cards, cell phones or PDAs that are not equipped with a magnetic stripe. For example, in one embodiment, the converter device 102 includes a magnetic stripe emulator 137 communicatively coupled to a wireless signal receiver 140 and adapted to provide a time-varying signal emulating data provided by a magnetic stripe card to a magnetic card reader 152.

The user device need not be a "card" and may, for example, take the form of a fob used as a key ring, a cell phone, a watch, a personal digital assistant or any device that can include a wireless transmitter, or a magnetic stripe emulator.

In various embodiments, the user device 104 employs near field signal to communicate with the converter device 102. In one embodiment, the near field communication is bi-directional such that the user device 104 may both send and receive wireless communication. That is, the user device includes a transceiver.

In general, the system interface 106 provides an interface to a larger information system (e.g., a financial system, an access control system, a medical records system, and the like) that in one embodiment includes a system processor or controller 110, a database 112, a network 114, other systems 116, such as a universal secure registry 118 as will be described further herein. Each of the preceding system elements may be placed in communication with any one or any combination of the system elements, for example, over communication links 120A, 120B, 120C, 120D. It should be recognized that the communication links 120 need not provide the communication paths shown in FIG. 28 and that other communication paths may be employed. For example, the database 112 may be connected to the network 114 via the communication link 120A and to the system processor 110 via the communication link 120B instead of being connected as shown in FIG. 28.

The communication link may be a wireless communication link, a hardwired communication link, a fiber optic communication link, any communication link used in the art, as well as a combination of any of the preceding or any other any communication link capable of transmitting signals between the elements of the system 100. The system processor 110 allows information transfer of both data and instructions, for example, between the interface 106 and one or more databases which may be connected to the system or other network elements.

In general, the operation of the converter device 102 allows a user in possession of the user device 104 to wirelessly communicate information to the device so that the device can be employed to interface with a network system. For example, in one embodiment, the network system may provide a magnetic card reader interface and the converter device 102 provides a magnetic stripe emulator that can interface with the system. In general, the overall operation of the system 100 includes the communication of information between the user device 104 and the converter device 102, for example, RF communication. In one embodiment, the communication is bi-directional such that information can be communicated both to and from the user device 104. The converter device 102 provides an interface by which information derived from the information being transmitted to or from the user device 104 is transmitted between the converter device and the system interface 106. The system interface 106 provides the communication interface between it and the remainder of the system 100 (e.g., processor 110, database 112, network 114, etc.).

According to one embodiment, the user device 104 includes a processor 122, a user interface 124, a wireless

transmitter **126** and device indicia **128**. In another embodiment, the user device **104** includes a biometric sensor **130**. In various embodiments, the processor **122** is communicatively coupled to each of the wireless transmitter **126**, the user interface **124** and the biometric sensor **130**.

The processor **122** may include a chip such as a general purpose processor, an application specific integrated circuit (“ASIC”), or a field programmable gate array (“FPGA”) and the like that may execute various programs and/or provide logic inputs and outputs. For example, the processor **122** may process biometric information received from the biometric sensor **130** to verify the identity of the user before the user can employ the user device **104**. Exemplary details of a processor and biometric sensor which are configured to authenticate a fingerprint of a user are disclosed in U.S. published application 2004/0133787, published on Jul. 8, 2004, which is herein incorporated by reference in its entirety. The processor **122** may also include or be coupled to driver circuitry to drive a display included in the user interface **124** and can be configured to process user input data entered via the user interface **124**. In one embodiment, the user interface **124** includes one or more control inputs (for example, control buttons).

The wireless transmitter **126** can process information provided by the processor and convert the information to an RF signal and can also include an RF antenna that transmits the RF information wirelessly. In another embodiment, the user device may also include an RF receiver that receives a wireless RF signal from the RF antenna and converts the RF signal to an information signal provided to the processor. It is to be appreciated that the wireless transmitter and/or receiver need not be an RF device, it can also be any of a IR device, an optical device, a Bluetooth signal or any other wireless signal transmitter or receiver used in the art.

The user device may also include a power source such as a battery that fits within the device. In one alternative embodiment, the user device remains in a sleep mode until it is placed in the vicinity of an RF transmitter at which time the user device **104** converts received RF energy into electrical energy used to provide power to the processor **122** and the other components included in the user device **104**.

According to one embodiment, the user device **104** can be a smart card configured for wireless signal transmission using RF signals. For example, the wireless transmitter **126** may be an RF transmitter device or any other wireless transmitter device configured to transmit the smart card information of the card. Alternatively, it is to be appreciated that the card can be many cards such as a debit card, a plurality of credit cards such as VISA, MasterCard, American Express, or any other card with the card indicia and relevant information being stored in card memory **129** and read out by processor **122** and provided to the wireless transmitter **126**. However, the user device **104** need not be in the form of a card and may instead include a cell phone or PDA.

In the embodiment illustrated in FIG. **28**, the converter device **102** includes a substrate **132** which may include a stripe **134** and a magnetic field generator **136** which together comprise the magnetic stripe emulator **137**, a processor **138**, a wireless receiver **140**, a user interface **142**, a memory **144**, and a power source **146**. In a further embodiment, the converter device **102** includes an indicating light **148** (e.g., an LED) and an output device **150**.

According to one embodiment, the system interface **106** with which the converter device **132** is employed includes any of or all of a magnetic card reader **152**, a wireless transceiver **154** and a data port **156**.

In general, according to one embodiment, the converter device **102** receives a wireless signal from the user device

104, processes the information that is received and provides an output in the form of a time-varying signal provided to the stripe **134** (e.g., a magnetic stripe). The signal provided to the stripe **134** can then be provided to the system processor **110** by inserting the stripe and the associated substrate **132** or portion thereof in the magnetic card reader of the system interface **106**. That is, in one embodiment, the stripe **134** and at least a portion of the substrate **132** can be either slid by the magnetic card reader **152** or inserted to sit statically in front of the read head of the card reader.

The processor **138** may be a general purpose processor, an application specific integrated circuit (“ASIC”), or a field programmable gate array (“FPGA”) and may be implemented in hardware, software, firmware or any combination of the preceding. The processor **138** may be communicatively coupled with any of the magnetic field generator **136** the wireless receiver **140**, the memory **144**, the user interface **142**, the light source **148**, the power source **146** and the output device **150**. In general, the processor can be configured to receive inputs from one or more of the preceding elements and may provide outputs to each of the elements included in converter device **138**.

For example, according to one embodiment, the magnetic stripe **134** is a programmable magnetic stripe and the magnetic field generator **136** generates a magnetic signal that controls the information provided by the magnetic stripe **134**. The U.S. patent application Ser. No. 10/680,050, filed Oct. 7, 2003, entitled “System Method and Apparatus for Enabling Transactions Using a Biometrically Enabled Programmable Magnetic Stripe” which was published on Jul. 8, 2004 as US2004/0133787 (the ’050 application), provides further details concerning embodiments of the user device that emulates a magnetic stripe and may also include, for example, a biometric sensor. The ’050 application is incorporated herein by reference in its entirety. In this embodiment, the processor **138** may control the operation of the magnetic field generator **136** to provide the desired information to the stripe **134**. For example, the processor **138** may provide an output to the stripe **134** in response to receiving information from the wireless receiver **140**, where the information from the wireless receiver is information transmitted from the user device **104**.

Further, the processor **138** may be configured to provide signals to drive a display included in the user interface **142** and process user input data entered with the user interface **142**. In one embodiment, the user interface **142** includes a display screen that can be used to display an image of the user to whom the user device **104** belongs, for security purposes. The image to be displayed by the UI can either be part of the information transmitted by the user device **104**, for example, where the user device **104** also requires some authentication by the user before transmitting the device information and image, or can be provided, for example, by the USR system **118** through the system interface **106** as part of the user authentication process, as will be described in more detail herein. In further embodiments, the user interface **142** may include a plurality of control elements that allow the user and/or the transaction processor (e.g., store clerk, security guard, medical service provider, etc.) to enter information into the converter device **102**. According to one embodiment, the user interface **142** includes an LCD display.

The processor **138** may also be configured to provide signals to operate the indicating light **148**. The indicating light **148** may provide an indication of the operational status of the converter device **102**, for example, the indicating light **148** may indicate any of the following: that the converter device **102** is receiving a transmission from a user device **104**; that the converter device **102** has generated output data to the

stripe **134**; the status of the power source **146** is normal or conversely that the power source has a low power level; that the converter device **102** is transmitting information via the output device **150**; that the converter device **102** is properly aligned with the magnetic card reader **152**; that the converter device **102** has received authorization for a transaction; and the like. It should be apparent to one of skill in the art that the indicating light may be a single lamp or a plurality of lamps and that the lamp or lamps may be a single color including white or may include a plurality of colors. Further, it should also be apparent that the lights may provide a plurality of status indications based on their color, intensity, rate of change of the preceding characteristics or any combination of these and other features.

The power source **146** may include a battery power source or other energy sources suitable for the form factor of the converter device **102**. For example, in a form factor where the converter device **102** is a hand-held device the power source **146** may be any one of a standard size battery (e.g., a AA battery). In a further embodiment, the power source is a lithium battery. Alternatively, the power source can be any of an AC power source, an AC to DC converter device, or any other DC power source known to those skilled in the art.

According to one embodiment, the converter device **102** includes a power bus **158** that provides a path for the transmission of power to the various components included in the converter device **102**.

In accordance with one embodiment, the converter device **102** includes the output device **150**. It is to be appreciated that the output device can be any standard interface device to be coupled to a data bus such as a USB device, or the output device can be configured for contactless communication with the system interface **106**. For example, in one embodiment, the output device is an optical transmitter device. In general, the communication between the converter device **102** and the system interface **106** is bi-directional such that information (e.g., information associated with the user's identity) may be transmitted to the system interface **106**, the system processor **110** may generate a response (e.g., a transaction approval), and the response may be transmitted to the converter device **102** via the system interface **106**.

In one embodiment, the processor **138** is configured in combination with the output device **150** to provide an encrypted output signal. In a further embodiment, the processor **138** is configured in combination with the output device **150** to provide a time-varying encrypted output signal. In yet another embodiment, the processor **138** is configured in combination with the output device **150** to provide a time-varying encrypted (or not) public and private key output signal. In addition, the processor can also be configured in combination with the wireless receiver to receive and decrypt any and all of an encrypted signal, a time-varying encrypted signal and a signal encrypted with a private key as provided by the user device **104**. A challenge-response protocol may also be employed alternatively or in addition to any of the preceding.

For example, embodiments of the invention may employ a protocol that does not require synchronized clocks in each of the user device **104** and the converter device and/or elsewhere in the system **100** to complete a validation and/or authentication process. That is, according to one embodiment, an information exchange between the user device **104** and the converter device **102** includes a first piece of information transmitted from the user device **104** to the converter device **102** and a subsequent challenge (e.g., an encrypted challenge) generated by the converter device and transmitted from the converter device to the user device **104**. According to one embodiment, the user employs the user device to respond to

the challenge. In one embodiment, the user's response is at least in part based on information included in the challenge. An identity of a user who responds accurately to the challenge can be successfully validated. In various embodiments, a challenge-response protocol includes an information exchange whereby the identity of the converter **102** is also authenticated by the user with the user device **104**.

In various embodiments, the above-described challenge-response protocol may not require any further action by the user than is required under current approaches that require synchronized clocks in disparate devices.

In some embodiments, the output device **150** need not transmit any personal information associated with the user. For example, commonly owned U.S. patent application Ser. No. 09/810,703, filed Mar. 16, 2001, entitled "Universal Secure Registry" ("the '703 application") describes an approach that can improve security and reduce the need for multiple forms of identification. The '703 application is incorporated herein by reference in its entirety. The universal secure registry **118** included in the system **100** provides one example of the integration of such a registry into a system that employs a converter device **102**. With the USR system, for example, the user device **104** can provide some information, e.g., such as a public code of the user, which can be authenticated by the user, for example by providing an ID through the user interface **124** or through biometric sensor **130**. The public code can be provided to the USR via the converter **102**, system interface **104**, and network **114**. The USR can then provide back to any of the system interface and the converter device any or all of device information (e.g., transaction card information), authorization for a transaction, e.g., where the network or the USR also communicates with the relevant authority, and indicia about the holder of the user device.

The system **100** may include a variety of system interfaces **106** of different types such as the wireless transceiver **154** and the data port **156** in addition to the magnetic card reader **152**. Although not illustrated, other system interfaces such as an optical interface, a smart card reader interface or any other system interface known to those of skill in the art can also be included. Further, the system interfaces may be either commonly located or may be geographically distributed such that some locations include a wireless transceiver **154**, some locations include a data port **156**, some locations include a magnetic card reader **152**, and some locations include a plurality of types of system interfaces.

Thus, in some embodiments the output device **150** of the converter device **102** may include a data port via which the converter device **102** can provide data to a network or a networked device. In one embodiment, the data port is also configured to receive data from the network or a networked device.

Embodiments of the converter device **102** can be configured to provide communication to the system interface **106** via any of the preceding approaches including wireless signal transmission. In a version of this embodiment, the converter device **102** may receive wireless signals from the user device and transmit wireless signals to the system interface **106**. Further, the converter device may include a transmitter that allows it to transmit information back to the user device.

Referring now to FIG. **29**, a process **260** employing the converter device **102** is illustrated in accordance with one embodiment. The process begins at Stage **262**—START. Here, the converter device **102** is in a steady state in which it awaits receipt of a signal from a user device **104**. At Stage **264**, the converter device **102** receives data, for example, a wireless signal transmitted from the user device **104**. At Stage **266**, the converter device **266** extracts information from the

wireless signal for processing. As one example, the converter device **102** may extract information corresponding to the user's identity and/or the identity of the individual to whom the user device was issued. The extracted information is then provided to the system interface, for example, it is simulated as magnetic striped data to the magnetic card reader. At Stage **268**, the system **100** authenticates the user. In one embodiment, if the authentication is successful, the process continues at Stage **270**. In this embodiment, if the authentication is unsuccessful, the process returns to Stage **262** where, for example, the user may be prompted to attempt to authenticate again.

Various user authentication approaches may be implemented using the converter device **102**. For example, the authentication may be performed locally, that is, without the need for communication between the converter device **102** and the system interface **106** and system processor **110**. In one embodiment, the authentication process employs the universal secure registry **118**. In further embodiments, the authentication process employs one or more authentication protocols such as public-key cryptography, key exchange protocols, protocols employing one-way functions, and the like that are well known by those of ordinary skill in the art. In other embodiments, however, the authentication may require an exchange of information between the converter device **102** and any of the system interface **106**, the network **114**, the USR **118** and another database **112**. A challenge-response protocol may also be employed alternatively or in combination with any of the preceding authentication approaches.

At Stage **270**, the completion of the transaction may be involve any of a wide variety of acts including: authorizing a withdrawal of money from a user's account, permitting the user access to a secure area, permitting a user to view medical information concerning themselves or a third party, or permitting the user to access other confidential information.

In addition, in some embodiments, the process **260** includes Stage **274** where following authentication the converter device **102** receives information associated with the user. The information may, for example, be necessary for the completion of the transaction. For example, where the system **100** is employed in conjunction with a check-authorization process, the converter device **102** may receive an indication that the user has sufficient funds to cover the amount of the check that is presented at a point of sale. Alternatively, or in addition, the information may include indicia related to the authorized holder of the user device **104**, such as a picture ID. The process **260** is completed at Stage **272**—END.

An embodiment, of the converter device **302** is illustrated in FIGS. **30A** through **30D**. As illustrated in the front view of FIG. **30A**, in one embodiment, the converter device **302** includes a housing **380**, a substrate **332**, and a magnetic stripe **334**. In one embodiment, the housing **380** is manufactured from a rigid material, for example, metal or plastic and the converter device **302** is designed to be a hand-held device. FIG. **30B** illustrates a side view perspective of an embodiment of the converter device **302**, showing an indicating light **348** (e.g., an LED). As described in greater detail above, the indicating light **348** can include a single indicating light or a plurality of indicating lights.

FIGS. **30A-30D** illustrate an embodiment where the substrate extends substantially perpendicular from a side of the housing **380**, however, the specific angle at which the substrate extends from the housing may vary so long as the housing does not interfere with the insertion of the substrate into, for example, the magnetic card reader **152**.

FIG. **30D** illustrates a top view of an embodiment of the converter device **302** which includes a display screen (e.g., an

LCD display screen) that may provide the user interface **342** or a portion of the user interface of the converter device **302**. In one embodiment, the user interface **342** includes a display screen that displays either a black and white or a color image of the individual to whom the user device **104** was issued. It should be recognized that the display screen may provide a wide range of functionality, for example, the display screen may display a variety of data received by the converter device **302** including data represented in alpha numeric format.

The magnetic stripe **334** may be a programmable magnetic stripe such that the converter device **302** provides a magnetic stripe emulator. In one embodiment, as has been described herein, the converter device **302** receives a wireless signal from a user device **104** and provides a time varying signal which emulates data provided by a magnetic-stripe card to a magnetic card reader in response to receiving the information from the wireless signal. In a further embodiment, the information is provided to the magnetic card reader by inserting the magnetic stripe **334** into the magnetic card reader.

The various embodiments of a system and method for converting a wireless transaction device to a magnetic stripe emulator device may include any of the following or any combination of the following: a converter device with a processor communicatively coupled to a wireless signal receiver and to a magnetic stripe emulator. The converter device may optionally include an LED. Further the processor may be configured for any combination of the following: control of the LED to indicate that the device is properly aligned with the magnetic card reader, control of the LED to indicate that the device has received authorization for a transaction, and where the converter device includes a power supply, a processor configured to control the LED to indicate that the device has power.

In one embodiment, the information received from the wireless signal by the converter device may include any of a name, a card number, user identification, a device code, amount of credit available, and an expiration date of the card for a transaction.

Further, in various embodiments, the converter device may include an output device that can provide information to a network or to a networked device. In various embodiments, the output device can be configured as a wireless transmitter device, such as an optical transmitter device.

In various embodiments the wireless transmitter device where the wireless transmitter may generally be configured as an RF transmitter device, and in particular, as a Bluetooth transmitter device.

In addition, in various embodiments, the processor can be configured in combination with the output device to provide any of an encrypted output signal, a time-varying encrypted output signal, and in particular, a time-varying public and private key output signal.

In further embodiments, the converter device may include an output device configured as a data port via which the converter device can provide data to a network or a networked device and to receive data from the network or a networked device.

In one embodiment, the converter device may also include an LCD screen for displaying at least some of the data received by the converter device, and a processor configured in combination with the LCD device to display indicia corresponding to the authorization of a transaction, and in particular, indicia that includes picture information of the cardholder.

In addition to the above described features, the various embodiments of a system and method for converting a wireless transaction device to a magnetic stripe emulator device

may include any combination of the following or any combination of the following and the above listed features: the converter device can be configured to communicate with the magnetic card reader via the data port; the wireless receiver and/or processor is configured to decrypt an encrypted wireless signal; the converter device is configured to decrypt a time-varying encrypted wireless signal; the converter device is configured to decrypt time-varying public and private key information contained within the wireless signal; the converter device includes a user interface communicatively coupled to the processor; the converter device processor is configured to determine whether the user is authorized to provide the information contained within the wireless signal from data provided through the user interface.

In addition, the following further additional features may be combined alone or in combination with the preceding: the data contained within the wireless signal received by the converter device may include any combination of the following: user I.D. information, biometric information of the user, secret information, (for example, a PIN, a password, or a passcode of the user), or information about an uncounterfeitable token of the user.

In various embodiments, the converter device may include a substrate housing the magnetic stripe emulator, and the substrate may include a programmable magnetic stripe.

In various embodiments, the system employed with the converter device may also include a system interface coupled to a network where the system interface includes a magnetic stripe reading device configured to read a time-varying signal. In a further embodiments, the system interface may be configured to transmit data received from the wireless transaction device to a networked credit card authentication entity also coupled to the network. The system may also include any of a keyboard, a printer, an (LCD) display, and an audio signal transducer.

Although the preceding description is primarily directed to an embodiment of the user device **104** that does not include a magnetic stripe, it should be recognized that some embodiments of the user device **104** may include a magnetic stripe. In these various embodiments, the converter device **102** may be employed to convert information coded on the magnetic stripe for transmission via another mode of information transmission.

Having thus described several aspects of at least one embodiment of this invention, it is to be appreciated various alterations, modifications, and improvements will readily occur to those skilled in the art. Such alterations, modifications, and improvements are intended to be part of this disclosure, and are intended to be within the spirit and scope of the invention. Accordingly, the foregoing description and drawings are by way of example only.

What is claimed is:

1. A method of controlling access to a plurality of secure computer networks, the method comprising:

using a secure registry system located remotely from the secure computer networks to control access to the plurality of secure computer networks, the secure computer networks including a first secure computer network and a second secure computer network, the secure registry system including:

a database containing selected data of a plurality of users each authorized to access at least one of the plurality of secure computer networks;

receiving first authentication information including a first non-predictable code at the secure registry system, the first authentication information provided by a first entity to the first secure computer network, the first authenti-

cation information generated with a first electronic ID device possessed by the first entity;

validating the first authentication information at the secure registry system, at least in part, by comparing the first non-predictable code to authentication information included in the database to determine whether the first non-predictable code corresponds to any of the plurality of users;

communicating from the secure registry system to the first secure computer network an indication of whether the first entity is authorized to access the first secure computer network, based on the validation, whereby the first entity is granted access to the first secure computer network where the first authentication information corresponds to a first one of the plurality of users and the first entity is denied access to the first secure computer network where the first authentication information does not correspond to any of the plurality of users;

receiving second authentication information including a second non-predictable code at the secure registry system, the second authentication information provided by a second entity to the second secure computer network, the second authentication information generated with a second electronic ID device possessed by the second entity;

validating the second authentication information at the secure registry system, at least in part, by comparing the second non-predictable code to the authentication information included in the database to determine whether the second non-predictable code corresponds to any of the plurality of users; and

communicating from the secure registry system to the second secure computer network an indication of whether the second entity is authorized to access the second secure computer network, based on the validation, whereby the second entity is granted access to the second secure computer network where the second authentication information corresponds to a second one of the plurality of users and the second entity is denied access to the second secure computer network where the second authentication information does not correspond to any of the plurality of users.

2. The method of claim **1**, wherein the database includes information to authenticate each of the plurality of secure computer networks, and

wherein the method further comprises an act of communicating validation information concerning at least one of the first secure computer network and the second secure computer network to the secure registry system.

3. The method of claim **2**, the method further comprising an act of determining, by the secure registry system, whether at least one of the first secure computer network and the second computer network is authorized to access the secure registry system.

4. The method of claim **1**, wherein the first non-predictable code includes a first time-varying code, and wherein the second non-predictable code includes a second time-varying code.

5. The method of claim **4**, wherein the first time-varying code and the second time-varying code each include a time-varying multi-character code, respectively.

6. The method of claim **1**, wherein the secure registry system is external from the plurality of secure computer networks.

7. The method of claim **1**, further comprising an act of controlling access to a physical facility using the secure registry system.

43

8. The method of claim 7, wherein the indication of whether the first entity is authorized to access the first secure computer network includes an indication of whether the first entity is authorized to access a first physical facility where the first secure computer network is located, and

wherein the indication of whether the second entity is authorized to access the second secure computer network includes an indication of whether the second entity is authorized to access a second physical facility where the second secure computer network is located.

9. The method of claim 1, further comprising acts of locating at least one of the secure computer networks at a first location at a site; and locating the secure registry system at a second location at the site, wherein access to the second location is, at least in part, controlled independently of access to the first location.

10. The method of claim 1, wherein the plurality of secure computer networks are located geographically remote from the secure registry system.

11. The method of claim 1, further comprising an act of employing the secure registry system to provide a centralized administration and management of the plurality of secure computer networks.

12. The method of claim 11, further comprising an act of maintaining, by the secure registry system, an audit trail concerning a use of the plurality of secure computer networks by at least one of the first user and the second user.

13. The method of claim 12, further comprising acts of: maintaining a first audit trail concerning the use of the plurality of secure computer networks by the first user; and maintaining a second audit trail concerning the use of the plurality of secure computer networks by the second user.

14. The method of claim 1, further comprising acts of: communicating the first authentication information from the first electronic ID device to the first secure computer network via at least one of a Bluetooth signal, an infrared signal and near-field communications, and communicating the second authentication information from the second electronic ID device to the second secure computer network via at least one of a Bluetooth signal, an infrared signal and near-field communications.

15. The method of claim 14, wherein each of the first electronic ID device and the second electronic ID device include a mobile phone, respectively.

16. The method of claim 15, further comprising acts of: communicating the first authentication information from the first electronic ID device to the first secure computer network via a first Bluetooth signal, and communicating the second authentication information from the second electronic ID device to the second secure computer network via a second Bluetooth signal.

17. The method of claim 1, further comprising an act of communicating between each of the first secure computer network and the second computer network, respectively, and the secure registry system over at least one of a wide area network, Internet and a wireless network.

18. The method of claim 17, further comprising an act of communicating at least one of the first authentication information and the second authentication information to the secure registry system over the Internet.

19. The method of claim 1, further comprising acts of: encrypting, by the first electronic ID device, the first authentication information;

44

encrypting, by the second electronic ID device, the second authentication information; and

decrypting, by the secure registry system, each of the first authentication information and the second authentication information, respectively.

20. The method of claim 1, further comprising acts of: encrypting, by the first secure computer network, the first authentication information;

encrypting, by the second secure computer network, the second authentication information; and

decrypting, by the secure registry system, each of the first authentication information and the second authentication information, respectively.

21. A secure registry system for controlling access to a plurality of secure computer networks, the secure registry system comprising:

a database including secure data for each of a plurality of users authorized to access at least one of the plurality of secure computer networks, wherein each user of plurality of users is associated with a non-predictable code, respectively;

a communication link to communicate information between the secure registry system and each of the plurality of secure computer networks; and

a processor coupled to the database and programmed to receive first authentication information including a first non-predictable code via the communication link, the first authentication information generated by a first electronic ID device possessed by a first entity and provided by the first entity to a first secure computer network of the plurality of secure computer networks to which the first entity seeks access, the processor programmed to compare the first non-predictable code to authentication information included in the database to determine whether the first non-predictable code corresponds to any of the plurality of users,

wherein the secure registry system communicates to the first secure computer network, via the communication link, a first indication that the first entity is authorized to access the first secure computer network where the first non-predictable code corresponds to a first user included in the plurality of users,

wherein the processor is programmed to receive second authentication information including a second non-predictable code via the communication link, the second authentication information generated by a second electronic ID device possessed by a second entity and provided by the second entity to a second secure computer network of the plurality of secure computer networks to which the second entity seeks access, the processor programmed to compare the second non-predictable code to the authentication information included in the database to determine whether the second non-predictable code corresponds to any of the plurality of users, and

wherein the secure registry system communicates to the second computer network, via the communication link, a second indication that the second entity is authorized to access the second secure computer network where the second non-predictable code corresponds to a second user included in the plurality of users.

22. The secure registry system of claim 21, wherein the secure registry system is located remotely from the plurality of secure computer networks.

23. The secure registry system of claim 22, wherein communication between the secure registry system and each of

45

the first secure computer network and the second secure computer network includes communication over a wide area network.

24. The secure registry system of claim 21, wherein the first non-predictable code includes a first time-varying multi-character code, and

wherein the second non-predictable code includes a second time-varying multi-character code.

25. The secure registry system of claim 21, wherein the processor is programmed to receive, in the first authentication information, first identifying information that identifies the first secure computer network and

wherein, where the first non-predictable code corresponds to the first user, the processor is further programmed to determine whether the first user is an authorized user of the first secure computer network.

26. The secure registry system of claim 25, wherein the processor is programmed to receive, in the second authentication information, second identifying information that identifies the second secure computer network, and

wherein, where the second non-predictable code corresponds to the second user, the processor is further pro-

46

grammed to determine whether the second user is an authorized user of the second secure computer network.

27. The secure registry system of claim 21, wherein each of the first electronic ID device and the second ID device include a mobile phone, respectively.

28. The secure registry system of claim 27, wherein the first entity communicates the first authentication information to the first secure computer network via a first Bluetooth signal using the first electronic ID device, and

wherein the second entity communicates the second authentication information to the second secure computer network via a second Bluetooth signal using the second electronic ID device.

29. The secure registry system of claim 21, wherein the first authentication information is encrypted by the first electronic ID device,

wherein the second authentication information is encrypted by the second electronic ID device, and

wherein the processor is configured to decrypt each of the first authentication information and the second authentication information, respectively.

* * * * *